

مسائل محلولة على برنامج الساب

إعداد

مهندس : خالد عبد الكريم

Eng.kh_ahmed@yahoo.com

01063366722 Or 01140506722

Beams

Ex :

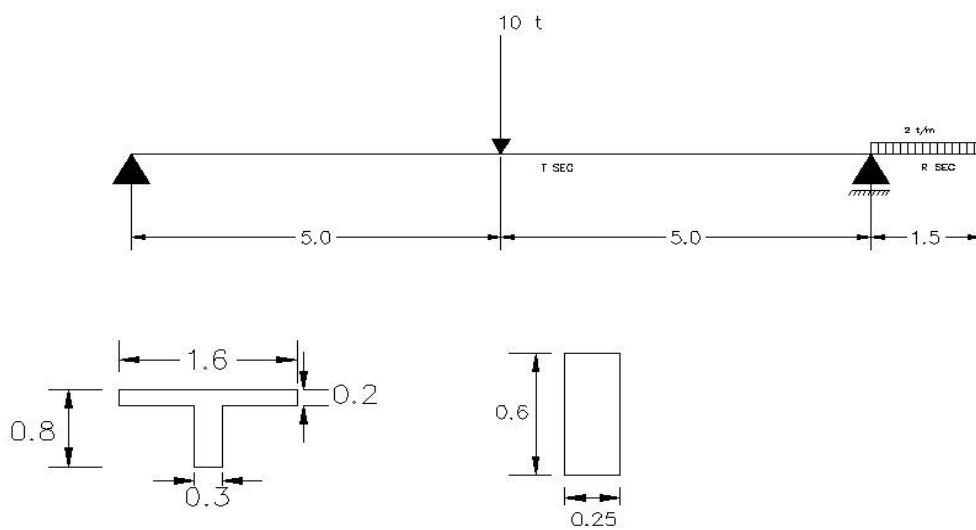

Material

RC

$\chi = 2.5$

$\mu = .22$

$E = 2000000$

Loads

$$L.L = 2 \text{ t/m}$$

$$F.C = 1.5 \text{ t/m}$$

Req

S.F.D & B.M.D

SOLUTION

- UNITES

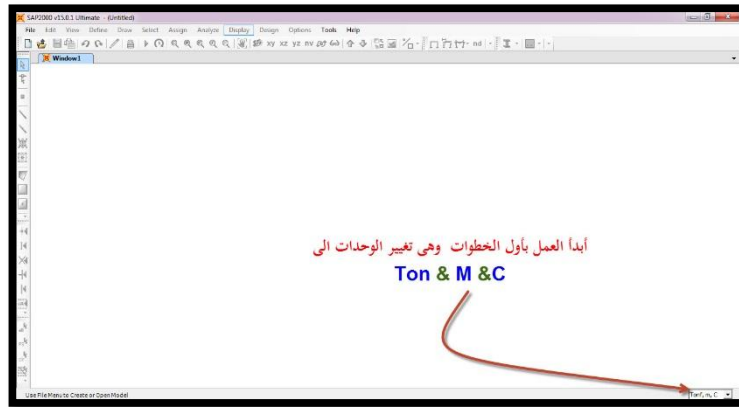

ثم اقوم باختيار New Model

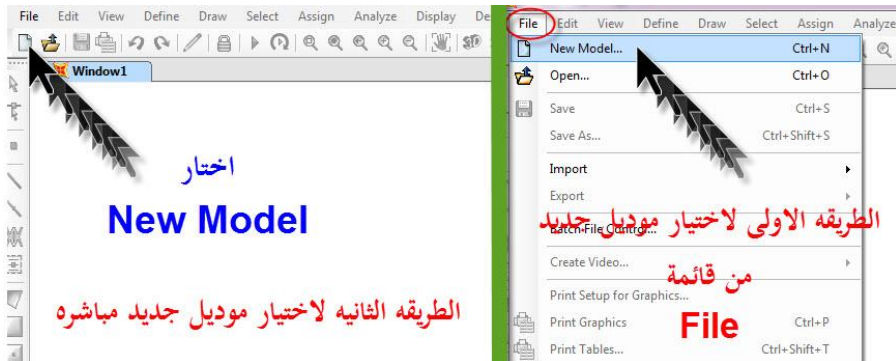

تظهر النافذة التالية بعد فتح موديل جديد

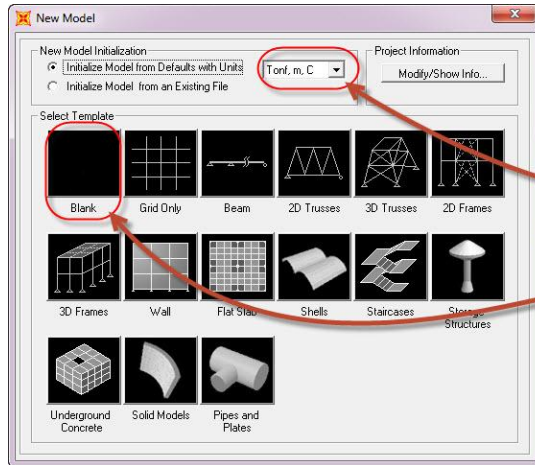

اذا لم نقم بتعديل الوحدات
في بداية العمل نقوم بتعديلها
من هذا الاختيار

نقوم بعد ذلك بتحديد
حاله
Blank

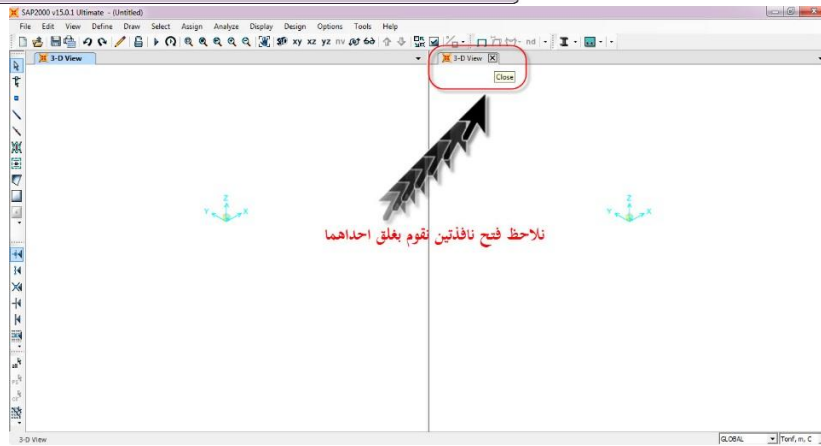

نلاحظ فتح نافذتين نقوم بغلاق احدهما



من هذة الاوامر نقوم باختيار
المستوى المناسب للعمل

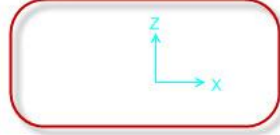

في حال العمل على
الكمرات فإننا نقوم باختيار
مستوى
xz Or yz

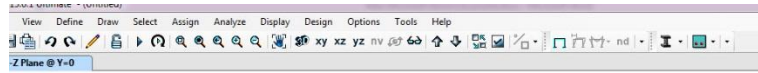

نضغط كليك يمين ونختار
Edit Grid Data



نختار تعديل

Define Grid System Data

Edit Format

System Name: GLOBAL Units: Tori, m, C Grid Lines: Quick Start...

X Grid Data

Grid ID	Ordinate	Line Type	Visibility	Bubble Loc.	Grid Color
1	0				
2	5				
3	10				
4	11.5				
5					
6					
7					
8					

Y Grid Data

Grid ID	Ordinate	Line Type	Visibility	Bubble Loc.	Grid Color
1					
2					
3					
4					
5					
6					
7					
8					

Z Grid Data

Grid ID	Ordinate	Line Type	Visibility	Bubble Loc.	Grid Color
1	0				
2	1				
3					
4					
5					
6					
7					
8					

Display Grids as: Ordinate Spacing

Hide All Grid Lines

Glue to Grid Lines

Bubble Size: 2.4384

Reset to Default Color

Reorder Ordinates

OK Cancel

في هذا الاختيار نقوم بادخال المسافات الخاصة بالمسألة بالجمع

هنا انا لست بحاجة لادخال مسافات ولكن قمت بادخال مسافة واحدة لظهور شبكة المسافات في اتجاه محور اكس

Define Grid System Data

Edit Format

System Name: GLOBAL Units: Tori, m, C Grid Lines: Quick Start...

X Grid Data

Grid ID	Spacing	Line Type	Visibility	Bubble Loc.	Grid Color
1	5				
2	5				
3	1.5				
4	0				
5					
6					
7					
8					

Y Grid Data

Grid ID	Ordinate	Line Type	Visibility	Bubble Loc.	Grid Color
1	0				
2					
3					
4					
5					
6					
7					
8					

Z Grid Data

Grid ID	Spacing	Line Type	Visibility	Bubble Loc.	Grid Color
1	1				
2	0				
3					
4					
5					
6					
7					
8					

Display Grids as: Ordinate Spacing

Hide All Grid Lines

Glue to Grid Lines

Bubble Size: 2.4384

Reset to Default Color

Reorder Ordinates

OK Cancel

في هذه الحالة اقوم بادخال المسافات التي تحركها لتعمل شبكة المسألة كمسافات بدون جمع

Coordinate/Grid Systems

Systems: GLOBAL

Click to:

Add New System...

Add Copy of System...

Modify/Show System...

Delete System

Convert to General Grid

موافقه

OK Cancel

شبكة الخطوط بعد تكوينها

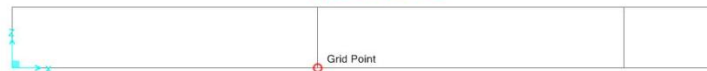

- Define Mterial

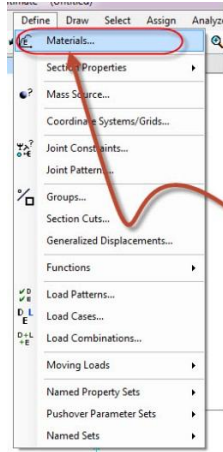

لادخال بيانات
المواد
المستخدمة في
العمل
خرسانه او ستيل

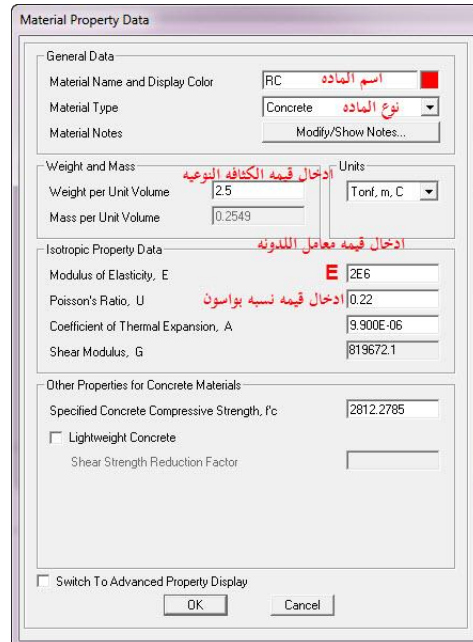
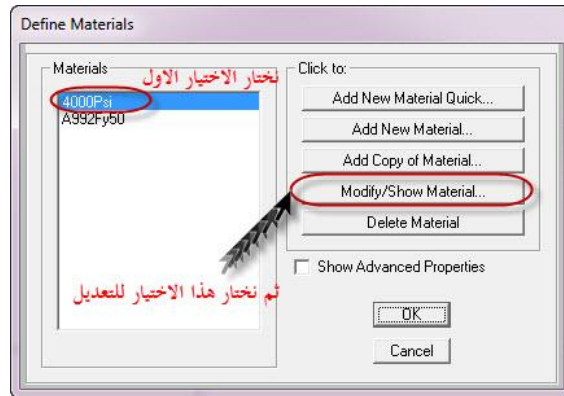

- Define Sections

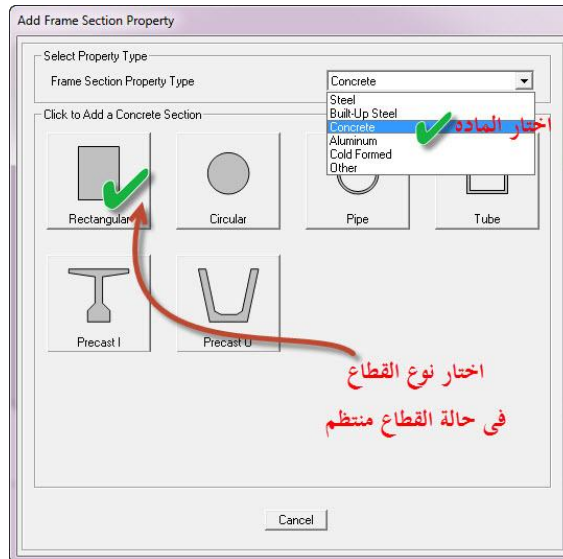
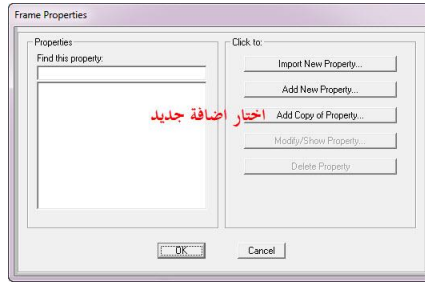
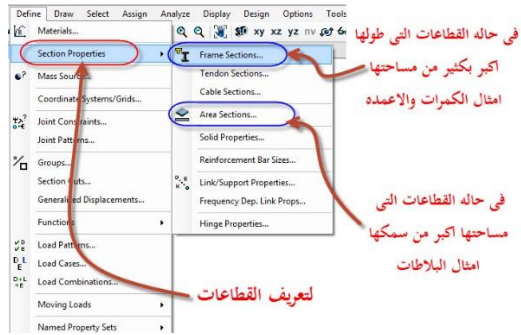

Rectangular Section

Section Name R SEC **اسم القطاع**

Section Notes

Properties Property Modifiers Material + RC

Dimensions

Depth (t3) عمق قطاع الكمره .6

Width (t2) عرض قطاع الكمره .25

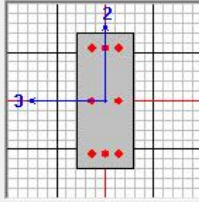









Display Color

Add Frame Section Property

Select Property Type **لتعريف قطاع حرف تي اختار تيوب ستيل**

Frame Section Property Type Steel

Click to Add a Steel Section

 I / Wide Flange	 Channel	 Tee	 Angle
 Double Angle	 Double Channel	 Pipe	 Tube
 Steel Joist			

اختار القطاع

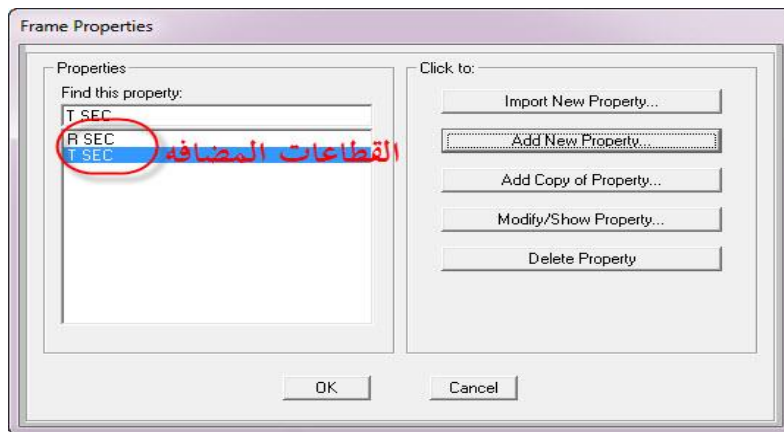
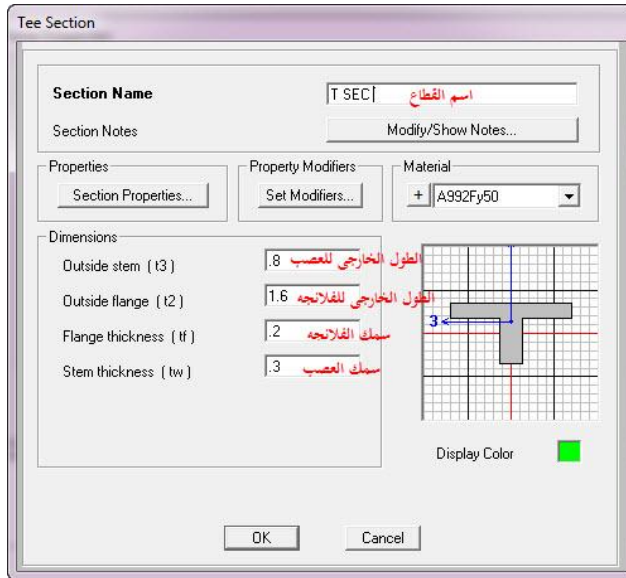

- Define Loads

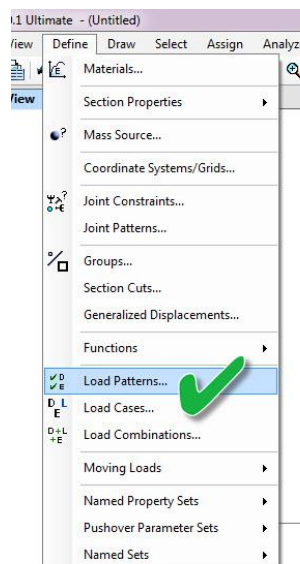

تعريف الاحمال

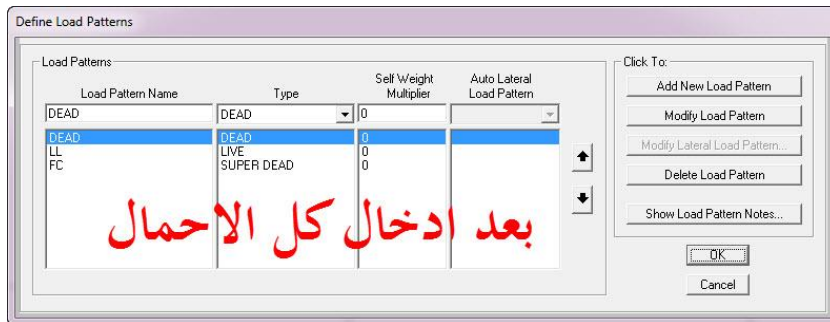
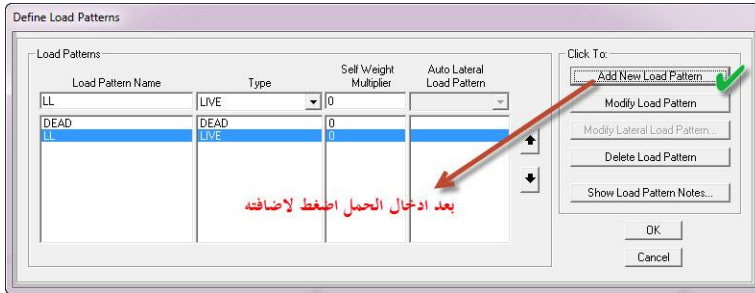
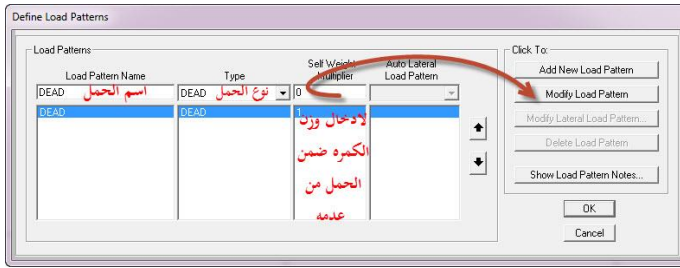

• Draw

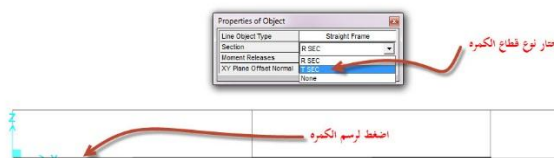

• Assign

لوضع الركائز احدد على مكان الركيزة بالماوس

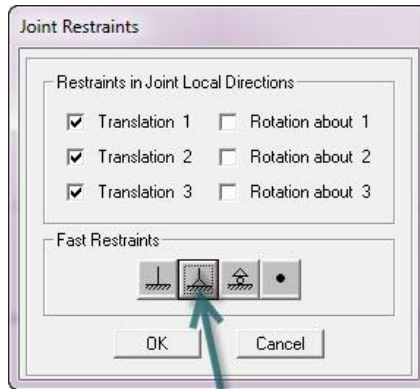
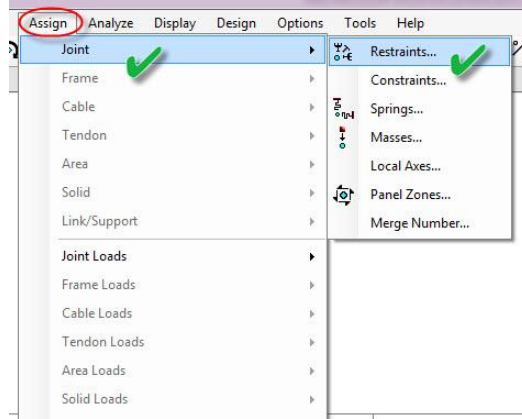

اختار نوع الركيزة عند النقطة المحدده

شكل الكبره بعد اضافه الركائز



لوضع الاحمال احدد على الكمرات المراد وضع الحمل عليها

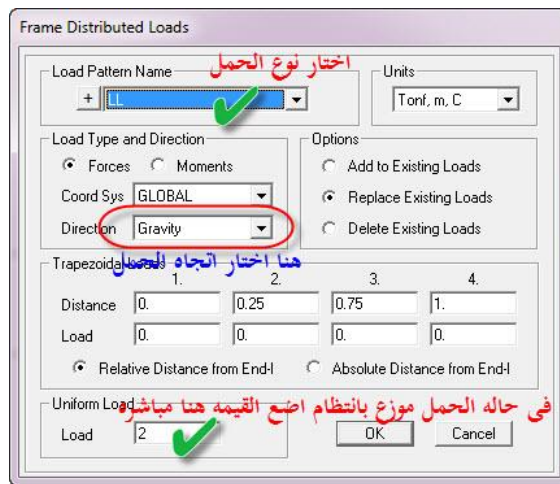
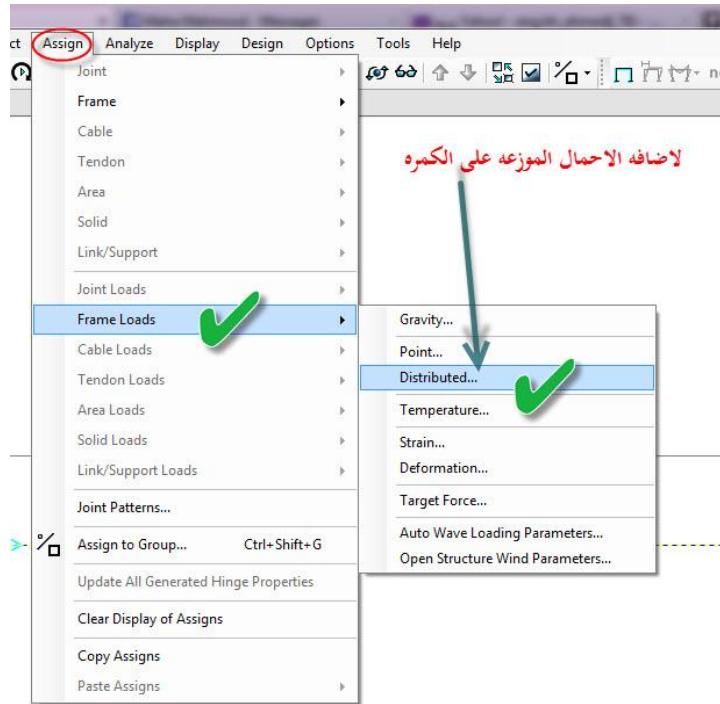

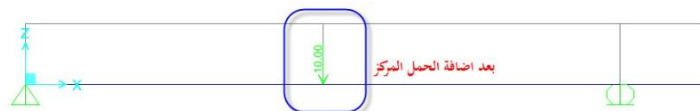
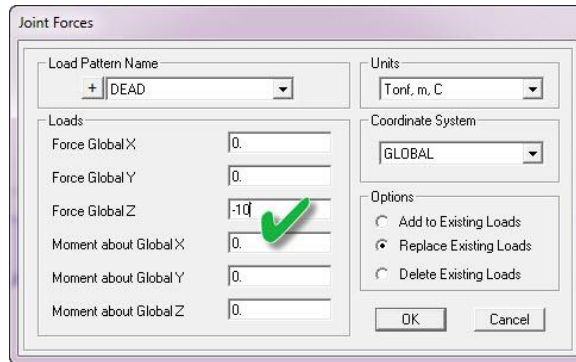
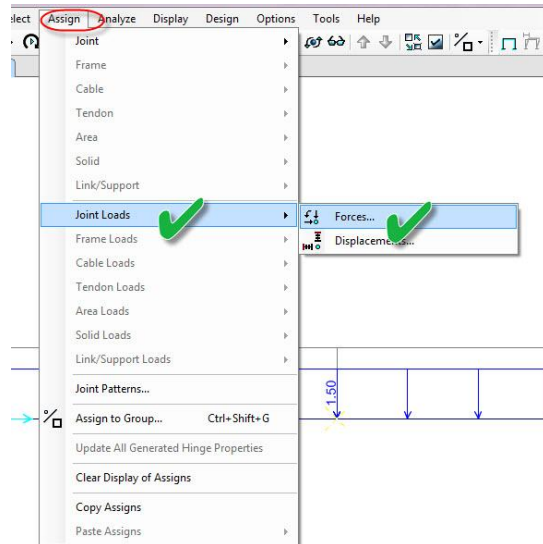

تحديد الكابولي لاضافة

الاحمال الميتة الموزعه

عليه

الشكل النهائي بعد الانتهاء من اضافة كل الاحمال والركائز

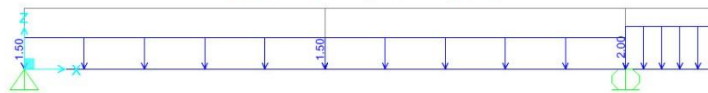

• Analyses



اضغط تشغيل

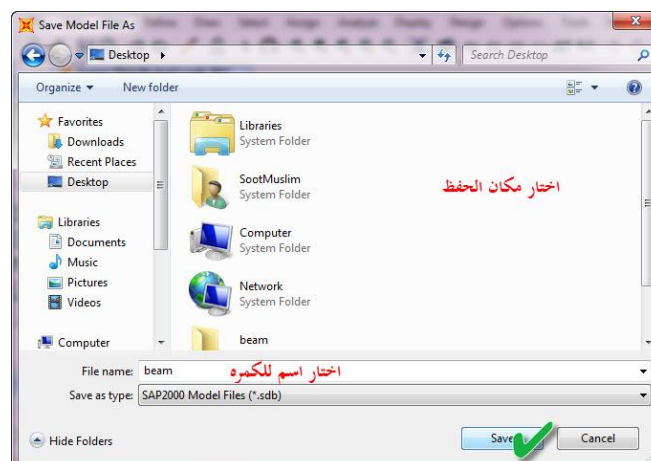
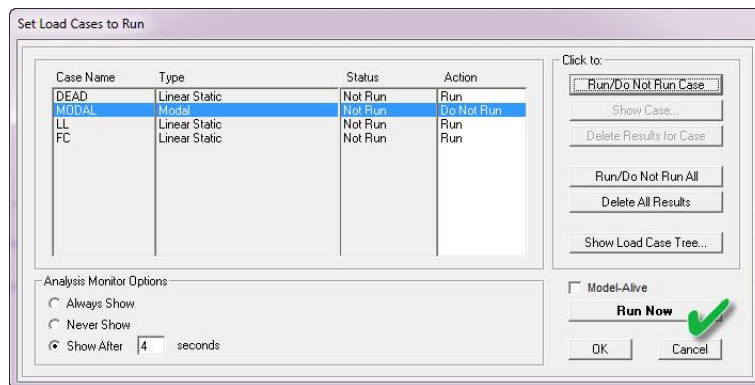
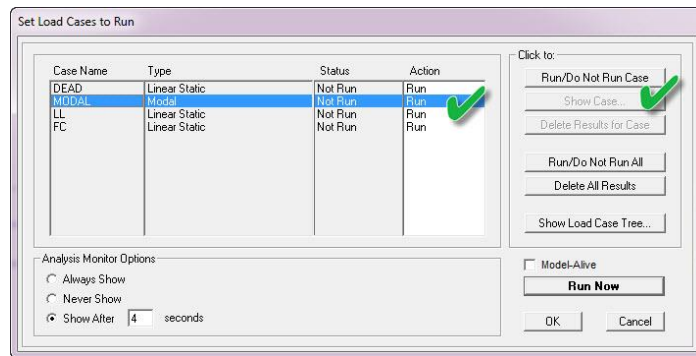

شكل الكمره نتيجة الاحمال

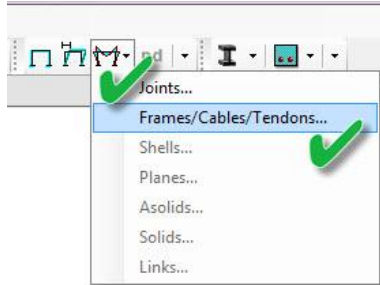

SFD

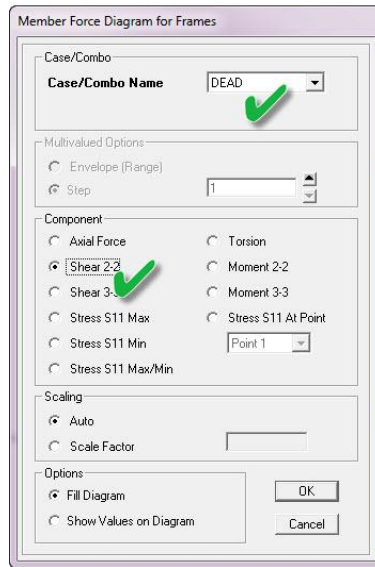

Member Force Diagram for Frames

Case/Combo
Case/Combo Name DEAD

Multivalued Options
 Envelope (Range)
 Step 1

Component
 Axial Force Torsion
 Shear 2-2 Moment 2-2
 Shear 3-3 Moment 3-3
 Stress S11 Max Stress S11 At Point
 Stress S11 Min Point 1
 Stress S11 Max/Min

Scaling
 Auto
 Scale Factor 1

Options
 Fill Diagram
 Show Values on Diagram

لاظهار قيم القص على الرسم

OK
 Cancel

قيمة قوى القص
SFD

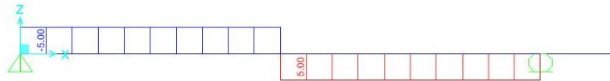

BMD

Member Force Diagram for Frames

Case/Combo
Case/Combo Name DEAD

Multivalued Options
 Envelope (Range)
 Step 1

Component
 Axial Force Torsion
 Shear 2-2 Moment 2-2
 Moment 3-3
 Stress S11 Max Stress S11 At Point
 Stress S11 Min Point 1
 Stress S11 Max/Min

Scaling
 Auto
 Scale Factor 1

Options
 Fill Diagram
 Show Values on Diagram

OK
 Cancel

مسائل محلولة على برنامج الساب

إعداد

مهندس : خالد عبدالكريم

Eng.kh_ahmed@yahoo.com

01063366722 Or 01140506722

www.facebook.com/Eng.Khaled.Abdelkarim

Frame

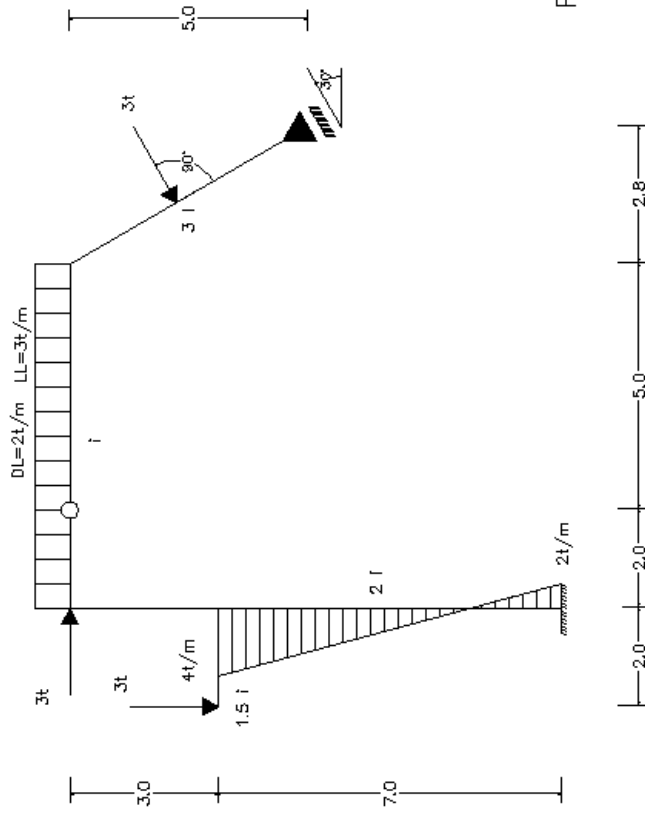

Material			
RC	$\alpha = 2.5$	$\mu = .22$	$EI = 4500$

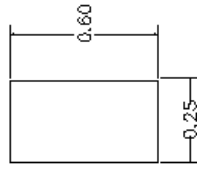

R SECTION

REQ: SFD & BMD IN WORKING AND UL CASE

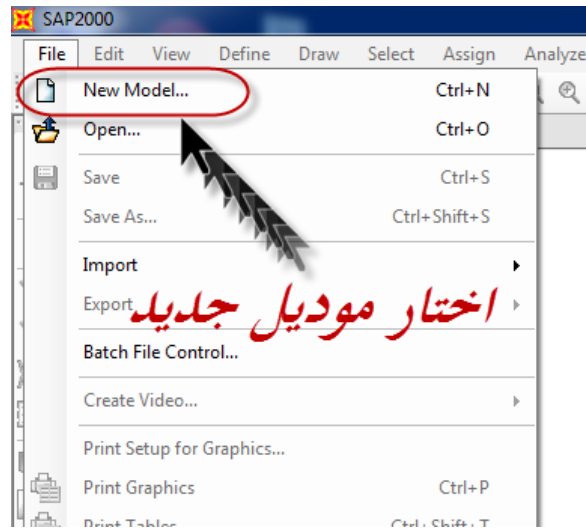
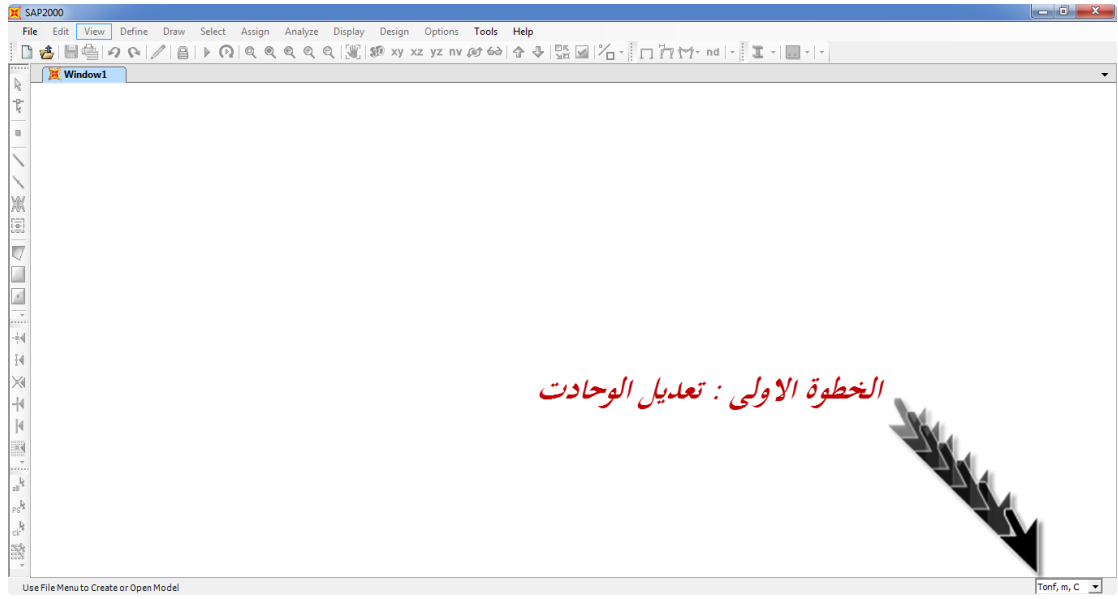

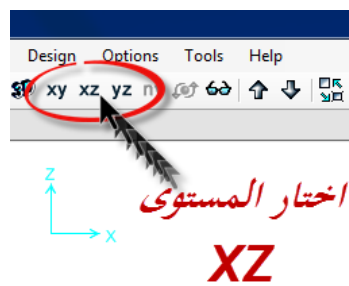
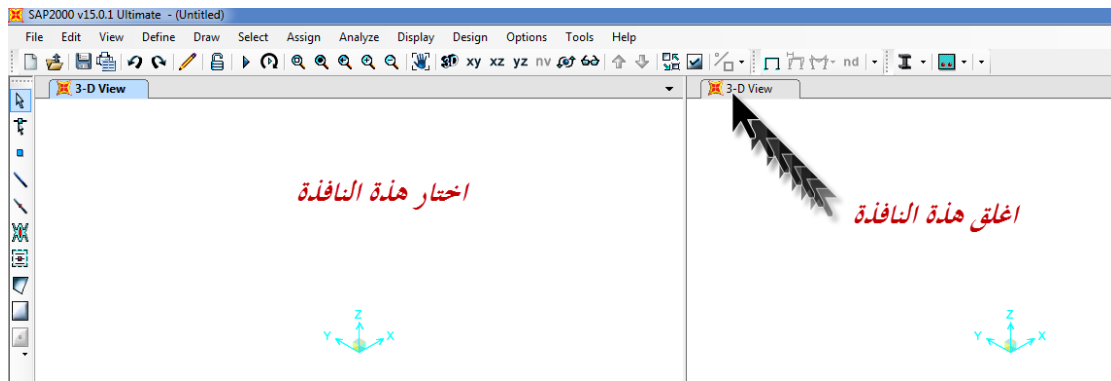
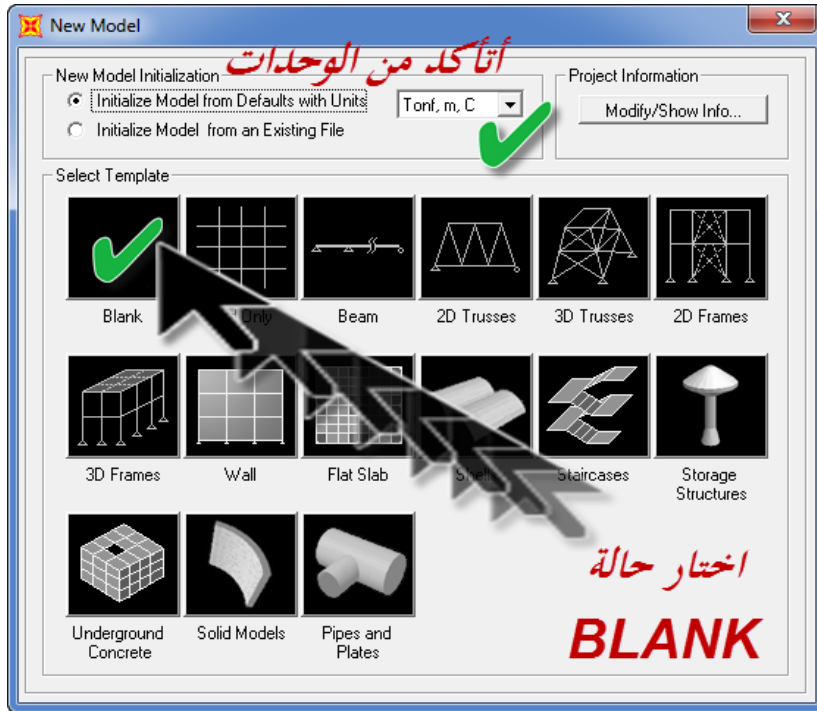

اضغط كليك يمين بالماوس في اى مكان على اللوحه

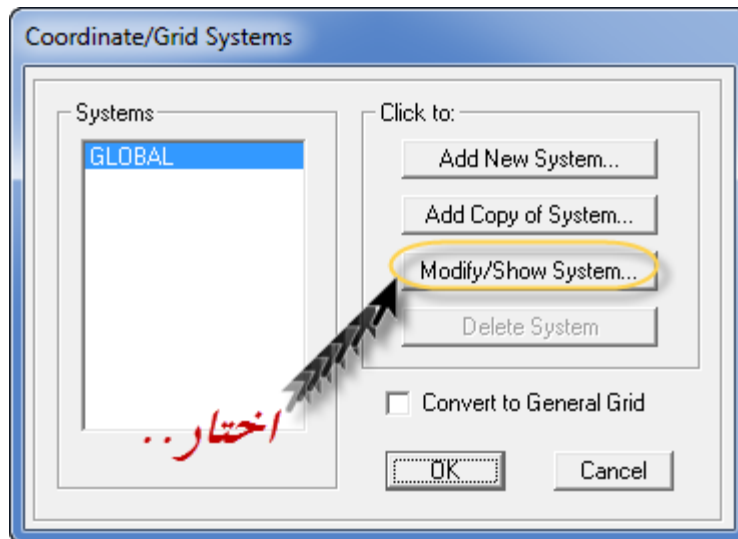
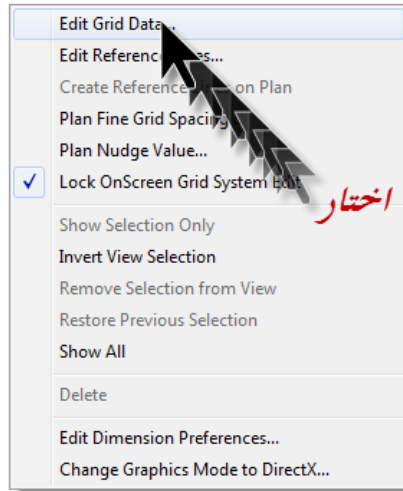

Define Grid System Data

Edit Format

System Name: GLOBAL Units: Tonf, m, C Grid Lines: Quick Start...

X Grid Data

	Grid ID	U	Line Type	Visibility	Bubble Loc.	Grid Color
1		2				
2		2				
3		5				
4		2.8				
5		0				
6						
7						
8						

Y Grid Data

	Grid ID	Line Type	Visibility	Bubble Loc.	Grid Color
1	0				
2					
3					
4					
5					
6					
7					
8					

Z Grid Data

	Grid ID	Line Type	Visibility	Bubble Loc.
1	0			
2	5			
3	2			
4	3			
5	0			
6				
7				
8				

Display Grids as: Ordinate Spacing

Hide All Grid Lines
 Glue to Grid Lines

Bubble Size: 2.4384

Reset to Default Color
Reorder Ordinate

OK Cancel

ادخل المسافات لعمل الشبكة
اختار الحاله

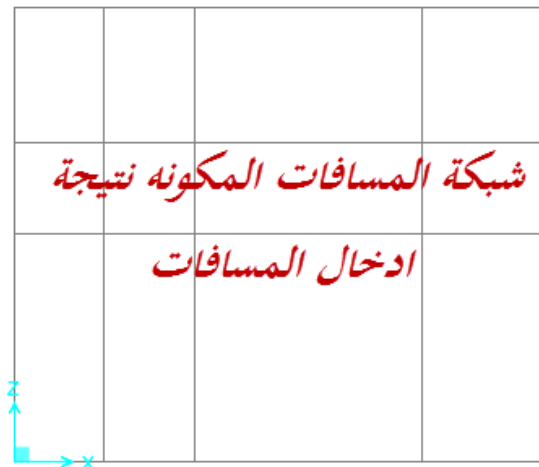

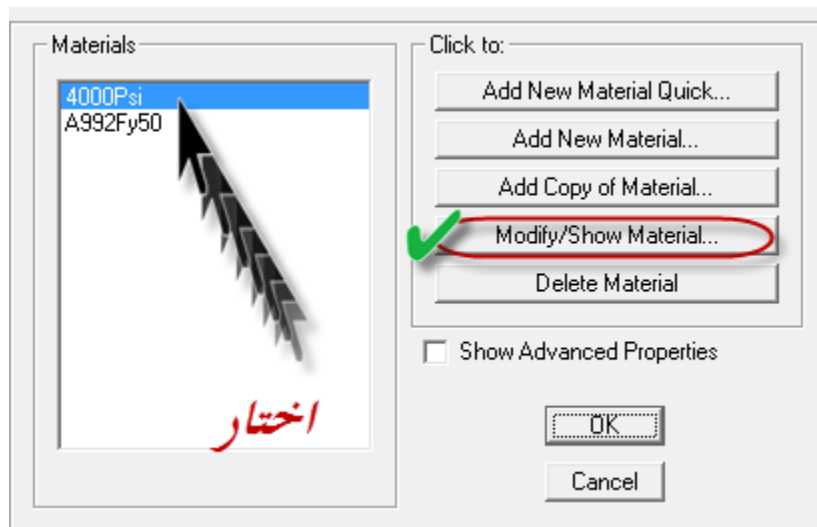
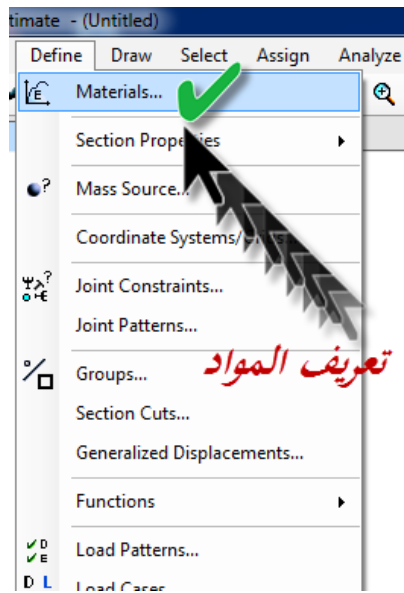

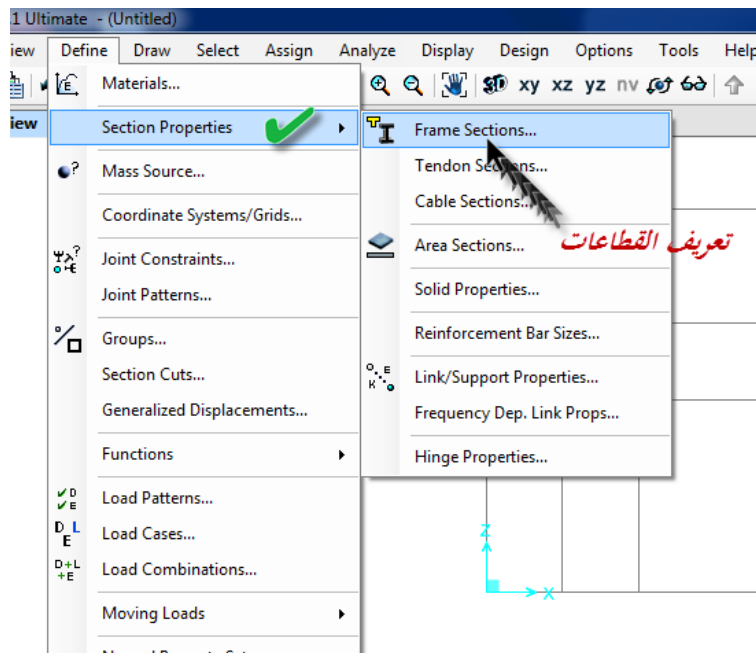
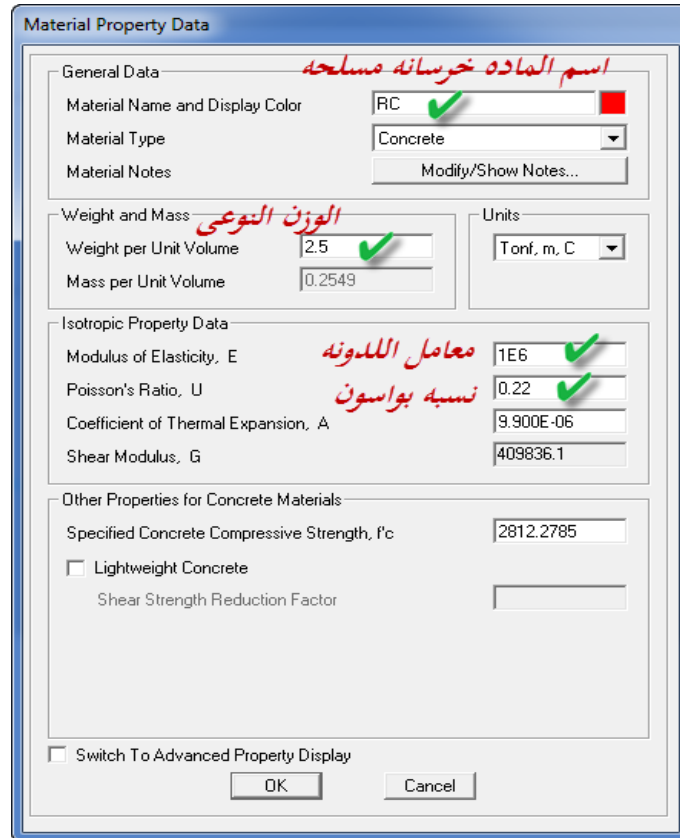

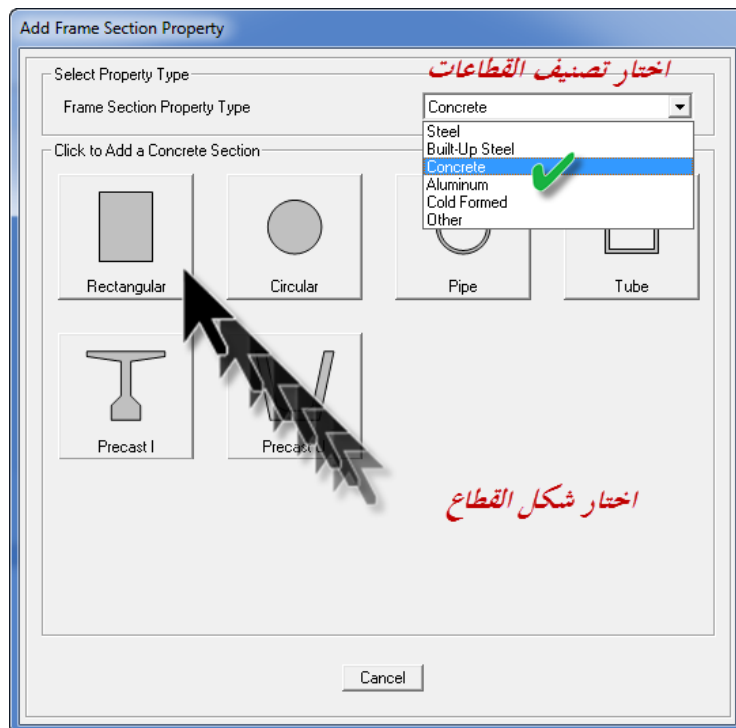
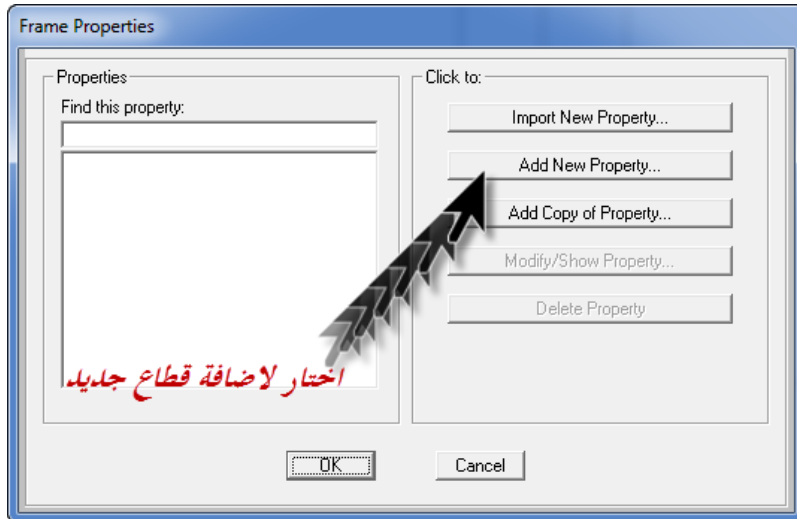

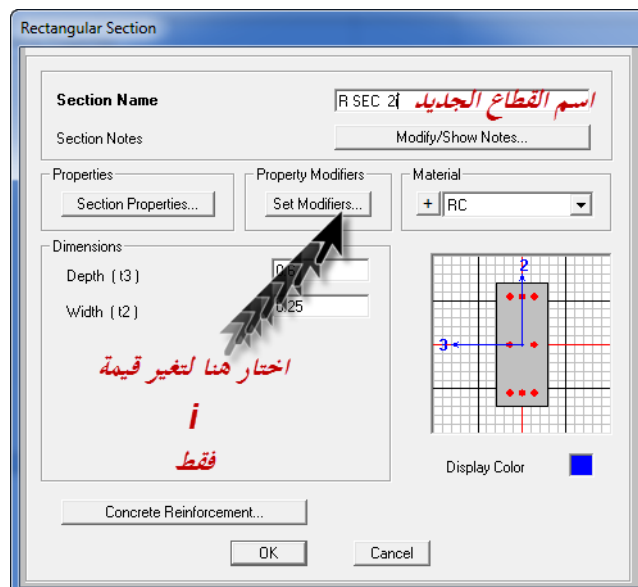
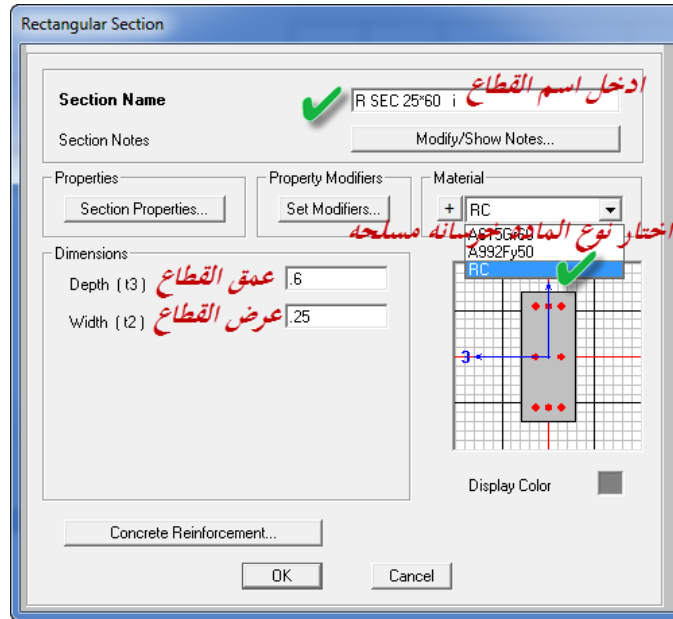

Property/Stiffness Modifiers for Analysis

Cross-section (axial) Area	1
Shear Area in 2 direction	1
Shear Area in 3 direction	1 <i>اقوم بتغيير</i>
Torsional Constant	1 <i>i</i>
Moment of Inertia about 2 axis	1
Moment of Inertia about 3 axis	2 <i>حول محور 2</i>
Mass	1 <i>y</i>
Weight	1

OK Cancel

Frame Properties

Properties

Find this property:

R SEC 25*60 1.5i

R SEC 2i

R SEC 25*60 i

R SEC 25*60 3i

R SEC 25*60 1.5i

تم تعريف كل القطاعات

Click to:

Import New Property...

Add New Property...

Add Copy of Property...

Modify/Show Property...

Delete Property

OK Cancel

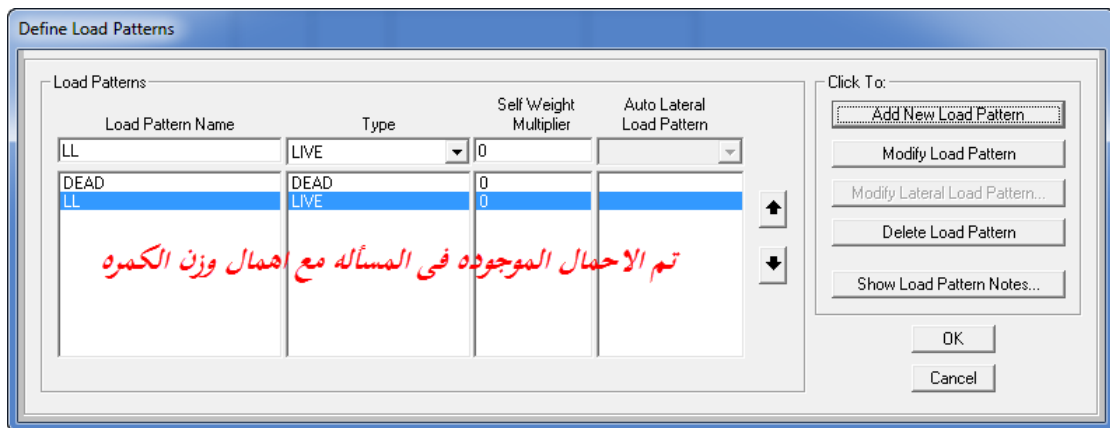
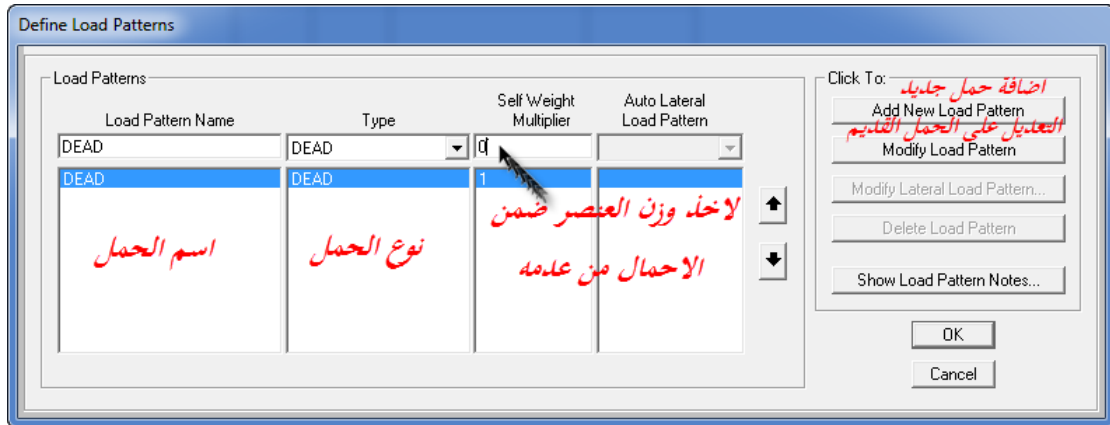
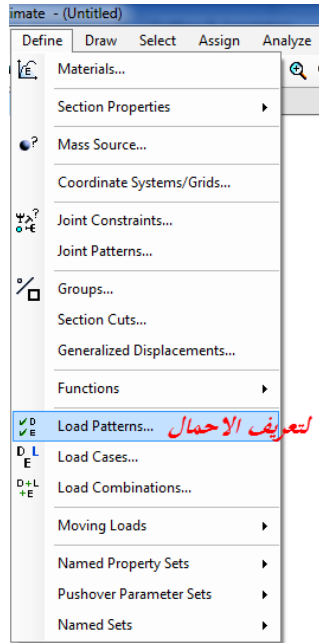

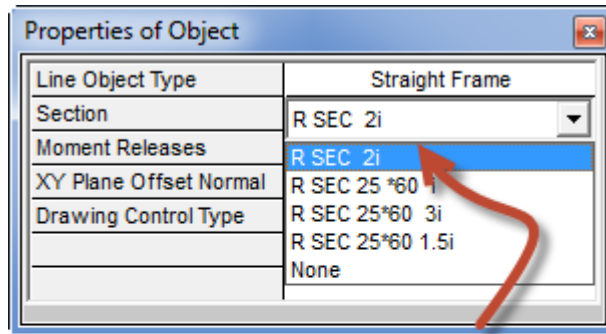
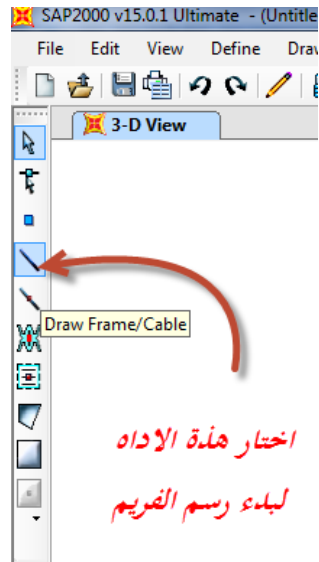

اختار القطاع المناسب وابدأ في الرسم

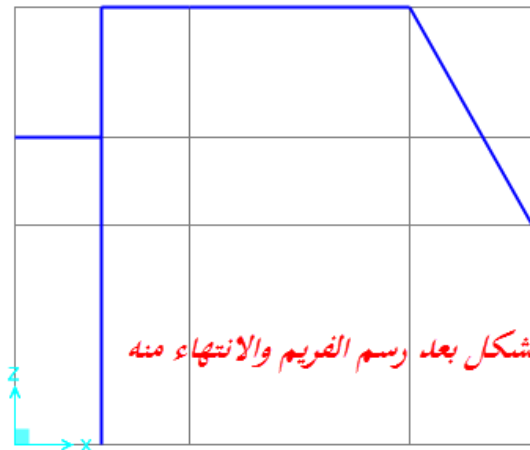

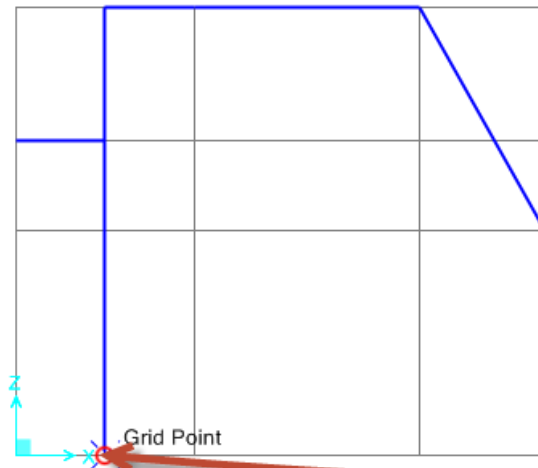

احدد لوضع الركيزة

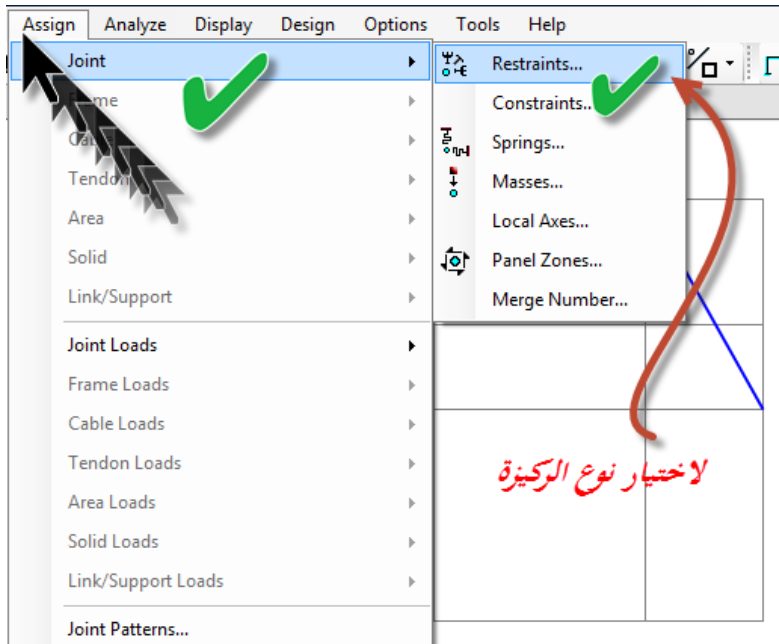

لاختيار نوع الركيزة

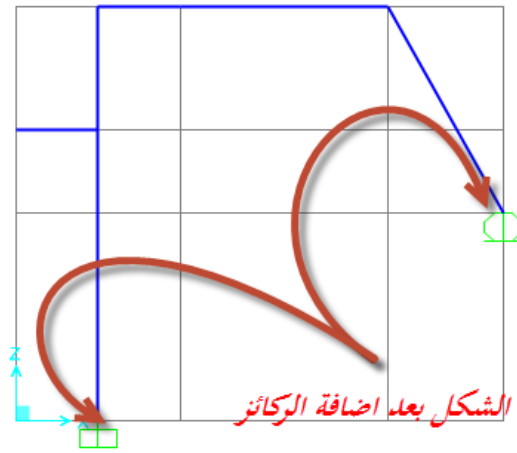

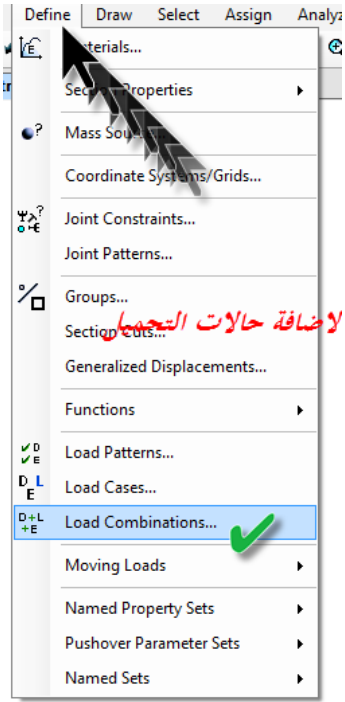

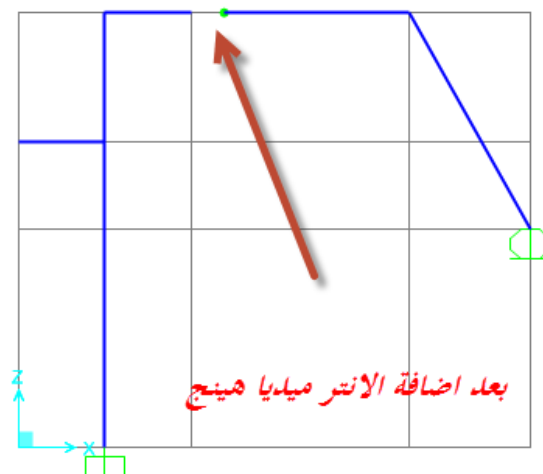
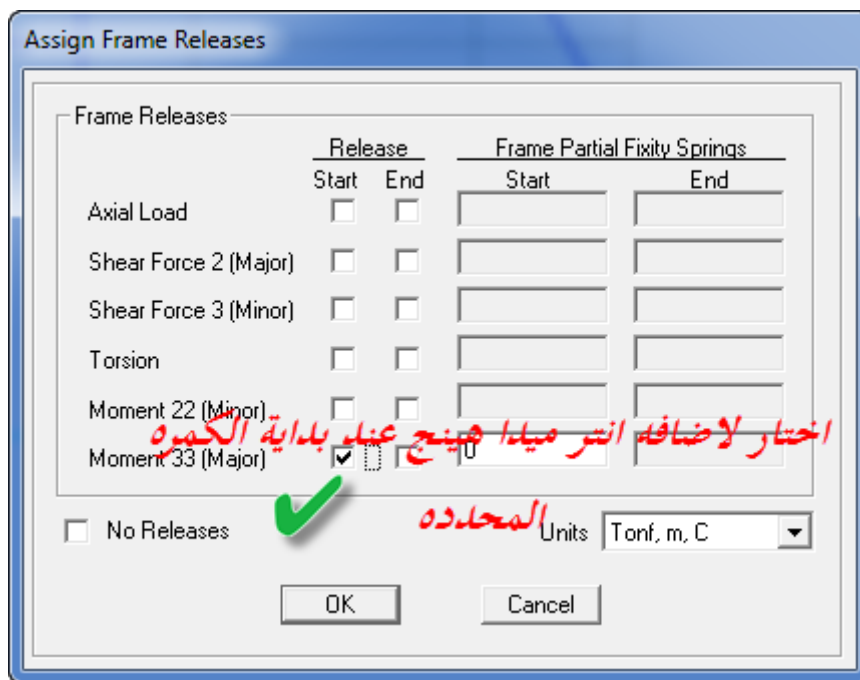
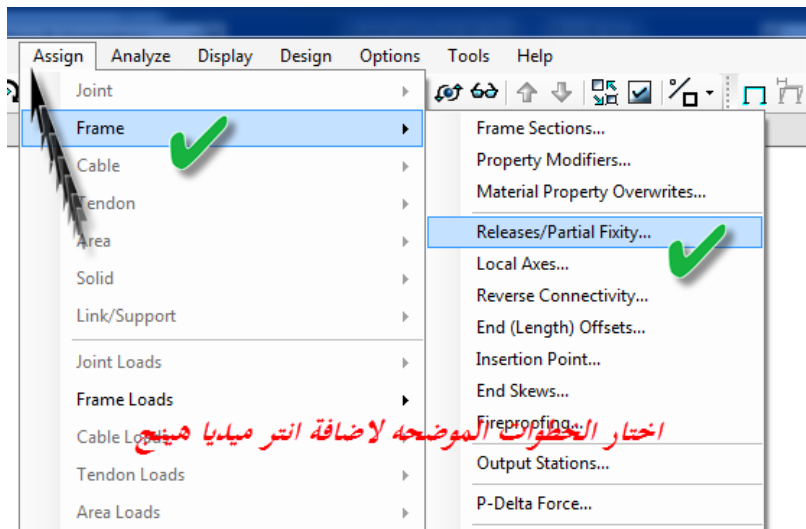

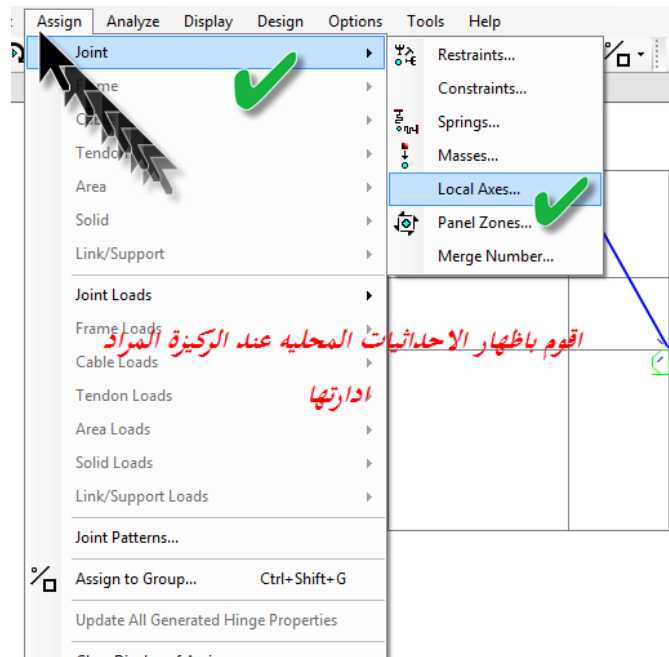
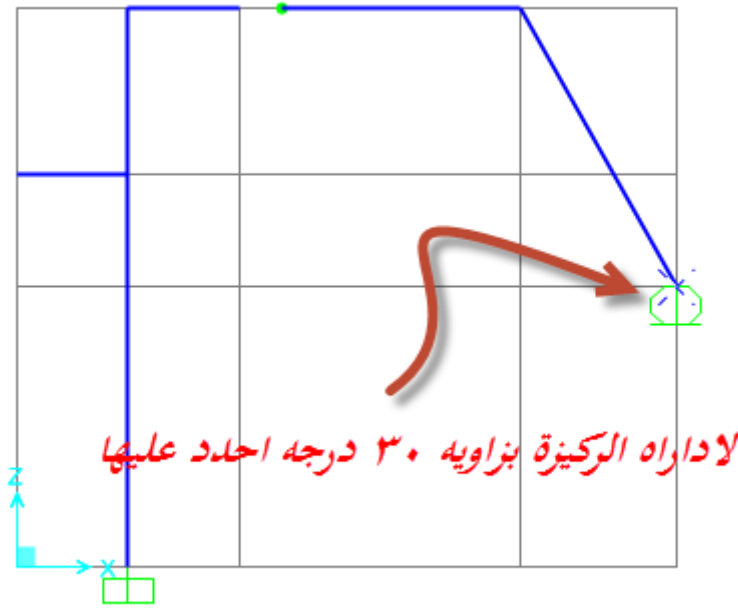

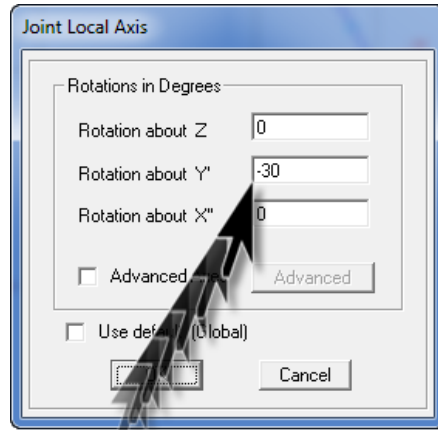

حدد الاستدارة حول محور .. واقوم
 بوضع قيمتها مع الاخذ فى الاعتبار
 ان الاشارة السالبة لتحديد اتجاه
 الدوران

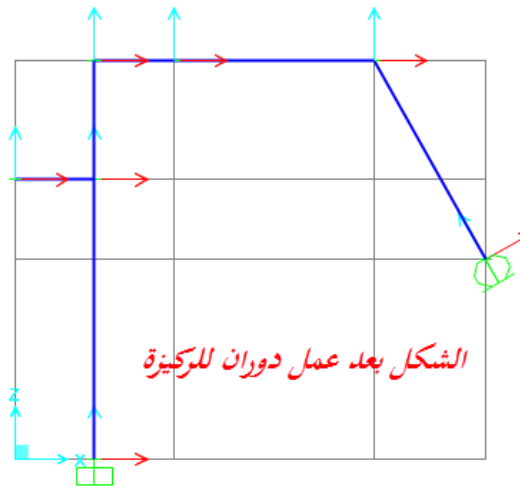

الشكل بعد عمل دوران للركيزة

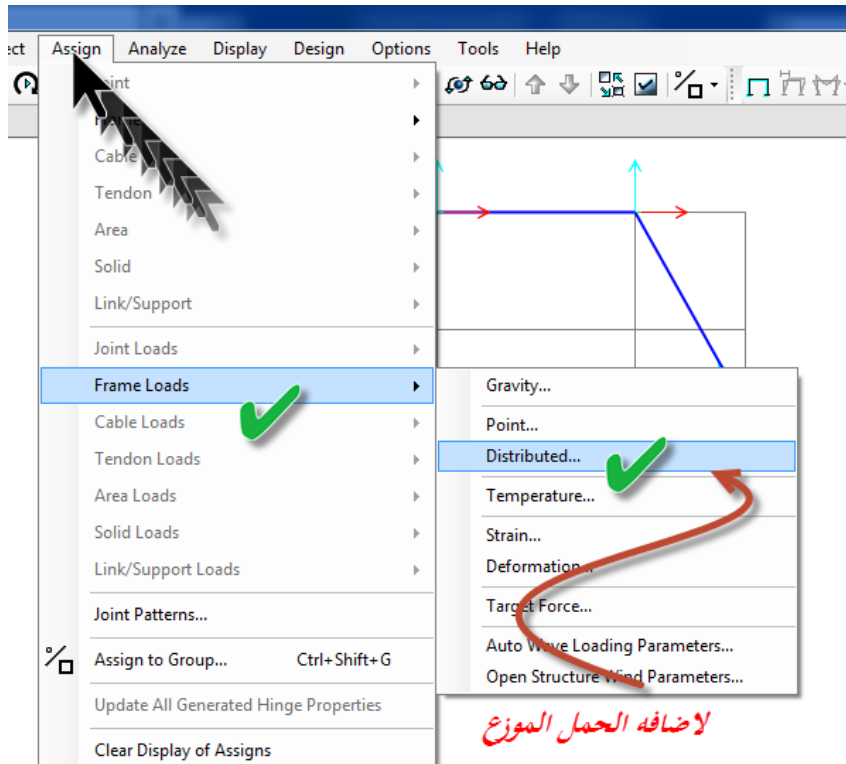
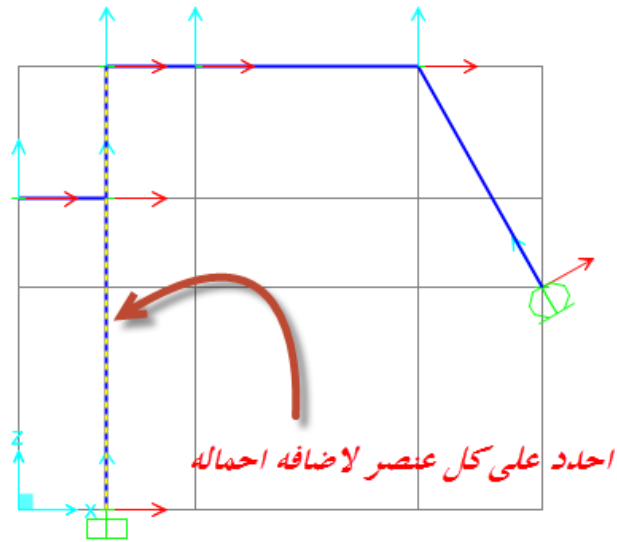

Frame Distributed Loads

Load Pattern Name: + DEAD *نوع الحمل*

Units: Tonf, m, C

Load Type and Direction:

- Forces Moments
- Coord Sys: GLOBAL
- Direction: *اتجاه تأثير الحمل*

Options:

- Add to Existing Loads
- Replace Existing Loads
- Delete Existing Loads

Trapezoidal Loads:

	1.	2.	3.	4.
Distance	0.	7.	0.	0.
Load	-2.	4.	0.	0.

ادخال قيم الاحمال
نوع طريقة الادخال للاحمال

- Relative Distance from End-I
- Absolute Distance from End-I

Uniform Load:

- Load: 0.

OK Cancel

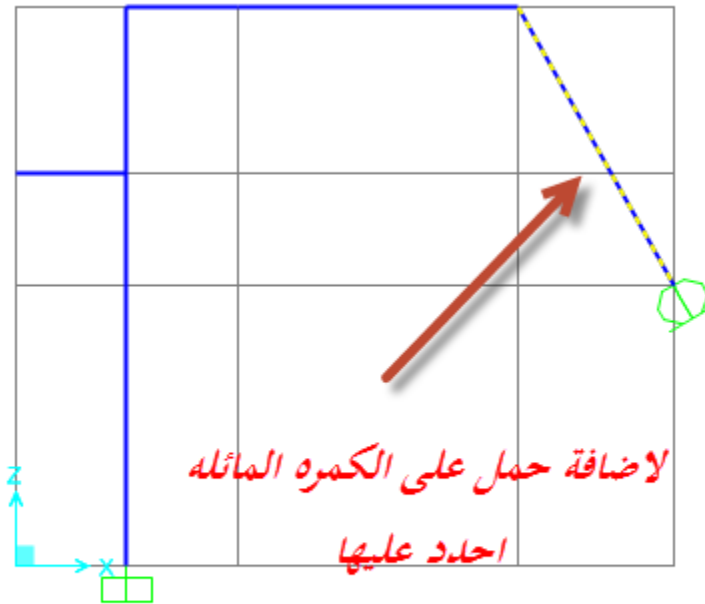

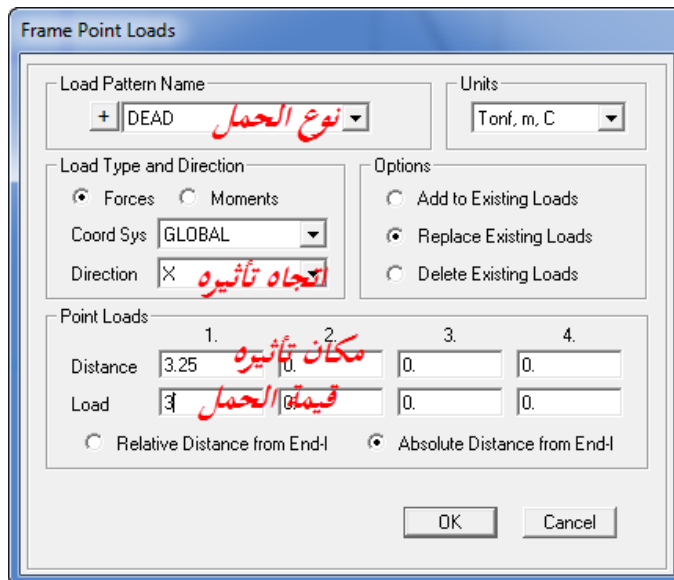
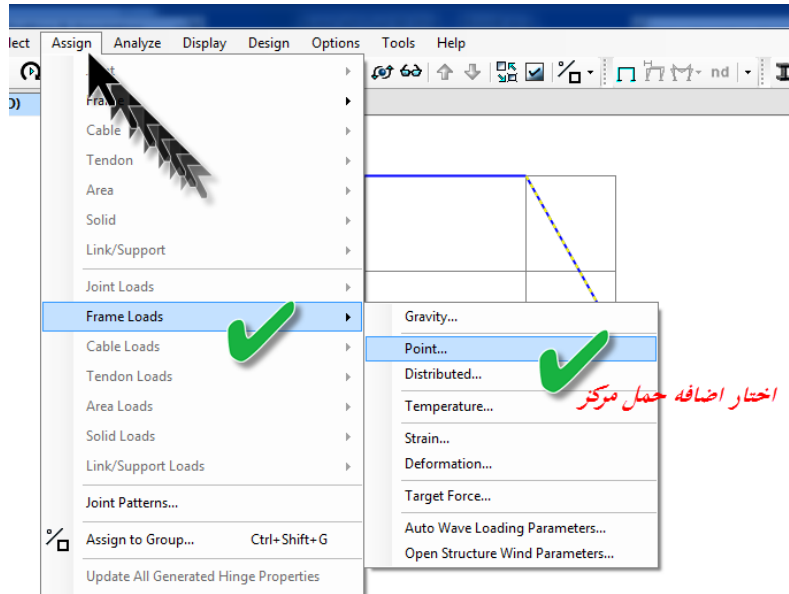

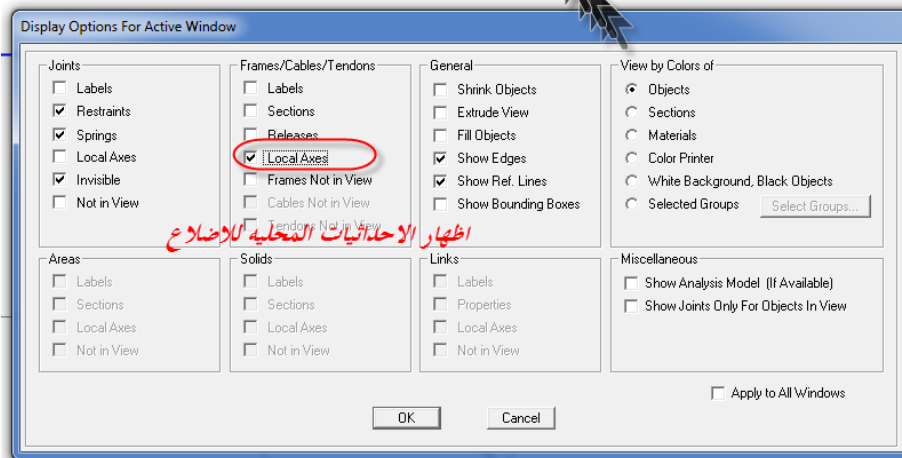
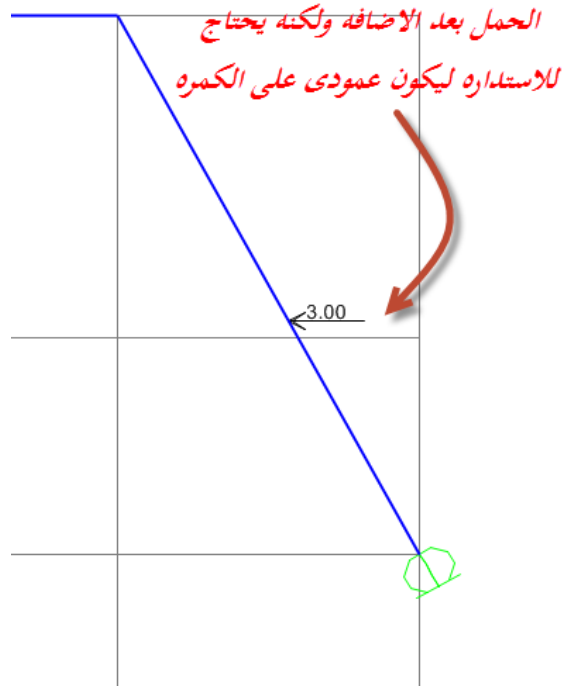

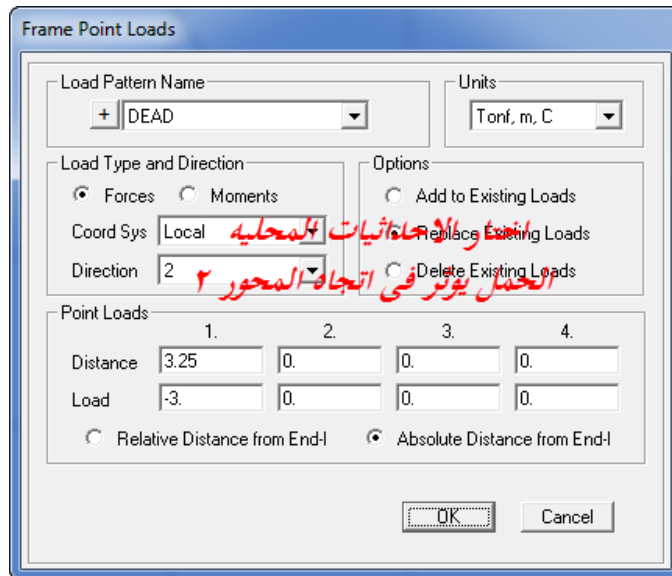
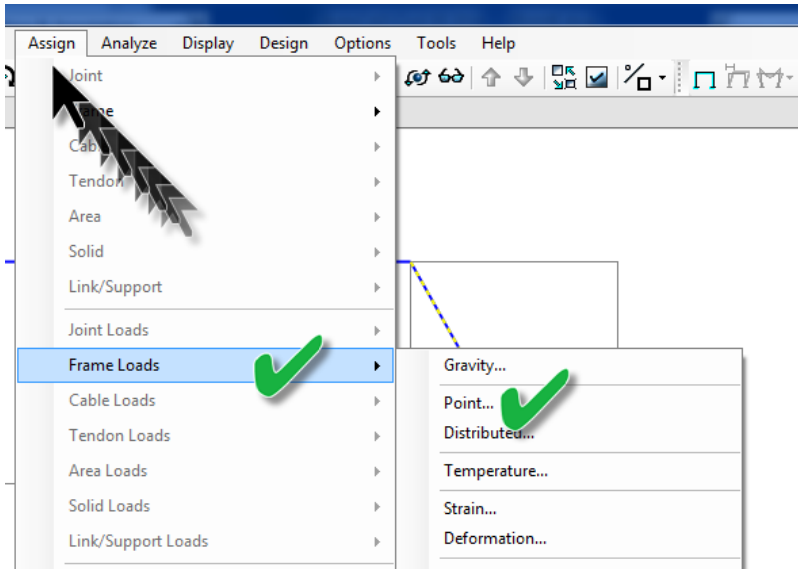

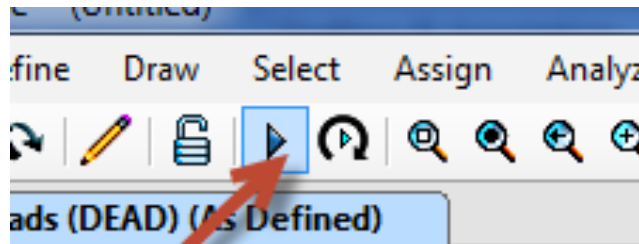
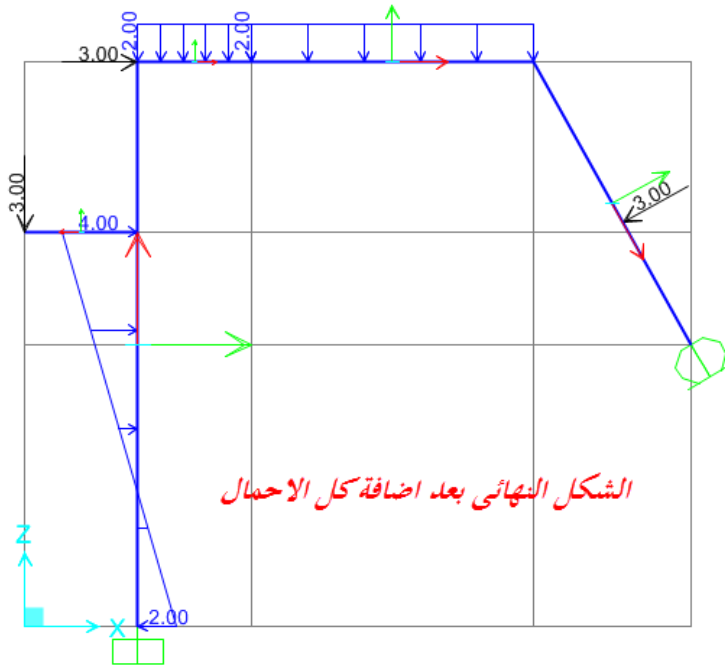

Run Analysis

اضغط لبدء التحليل

Set Load Cases to Run

Case Name	Type	Status	Action
DEAD	Linear Static	Not Run	Run
MODAL	Modal	Not Run	Do Not Run
LL	Linear Static	Not Run	Run

Click to:

Run/Do Not Run Case

Show Case...

Delete Results for Case

Run/Do Not Run All

Delete All Results

Show Load Case Tree...

Analysis Monitor Options

Always Show
 Never Show
 Show After 4 seconds

Model-Alive

Run Now

OK Cancel

ثم اختار

ثم اختار

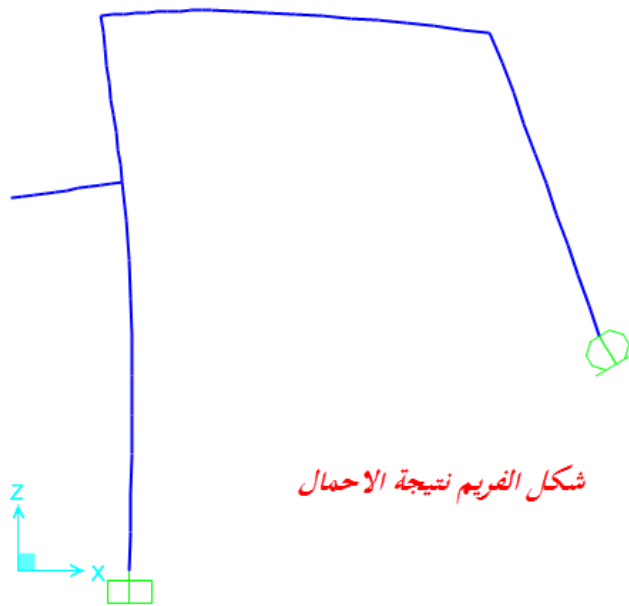
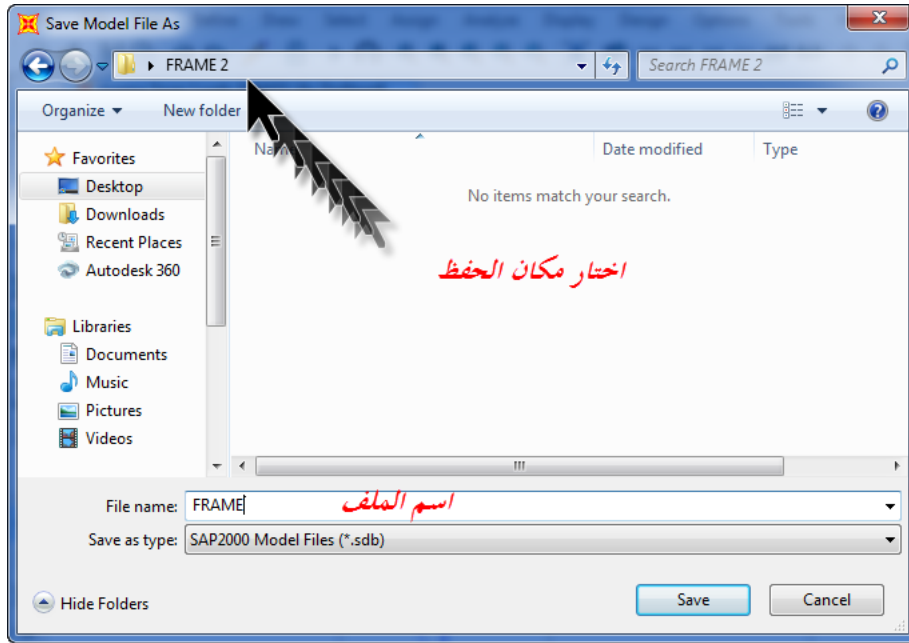

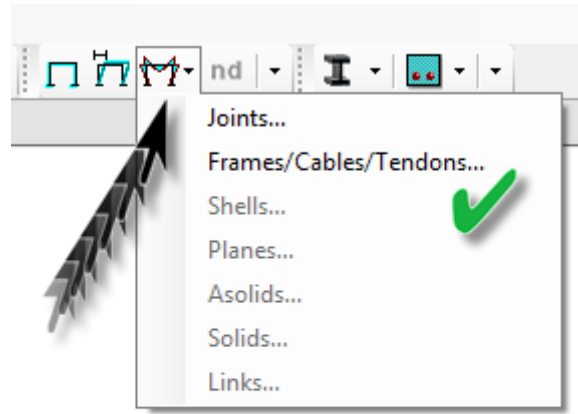

لاظهار قوى القص والعزم

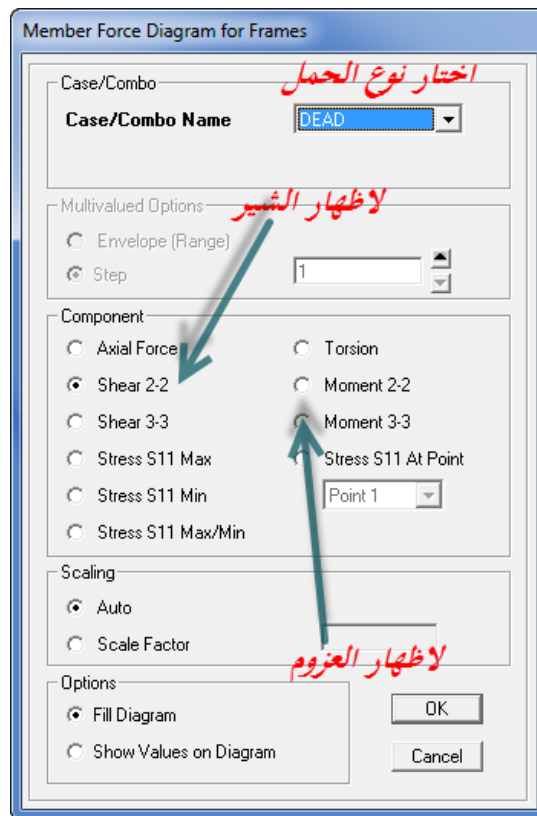

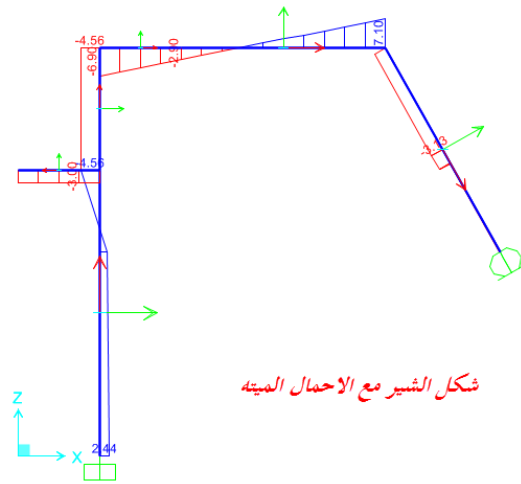
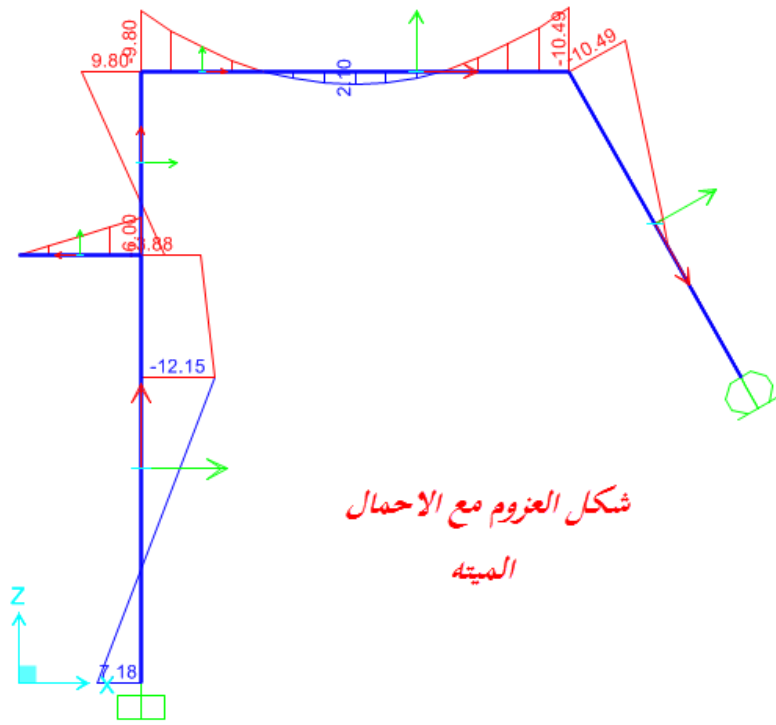

مسائل محلولة على برنامج الساب

إعداد

مهندس : خالد عبد الكريم

Eng.kh_ahmed@yahoo.com

01063366722 Or 01140506722

www.facebook.com/Eng.Khaled.Abdelkarim

TRUSS

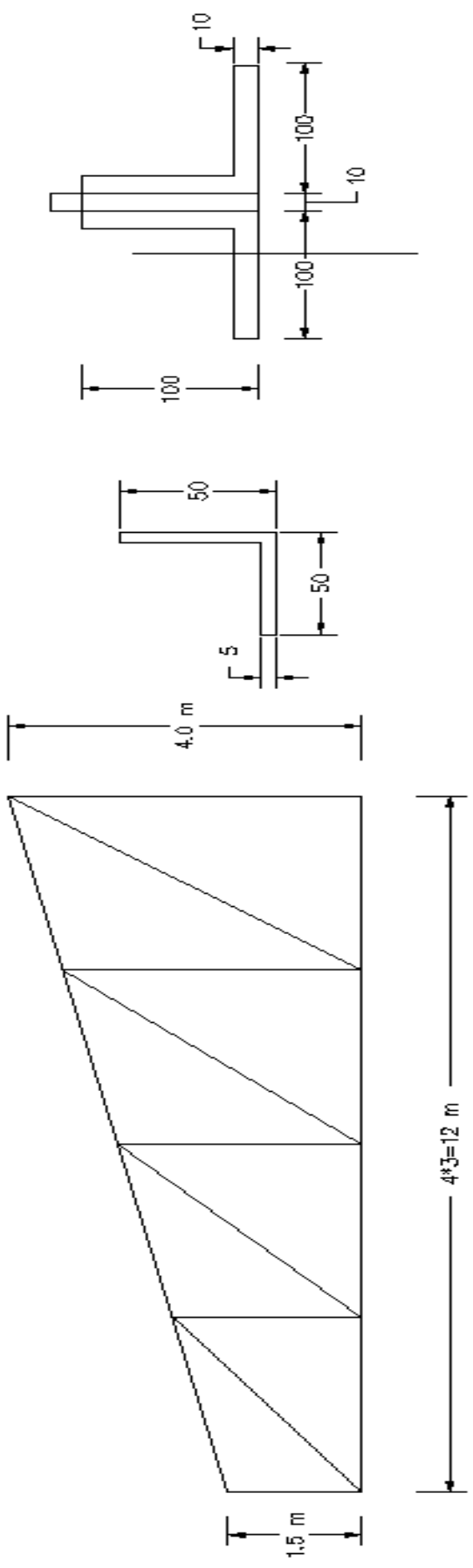

Upper and Lower Chords are 2 angles back to back 100*100*10

Vertical and Diagonal member are one angle 50*50*5

[reframe]

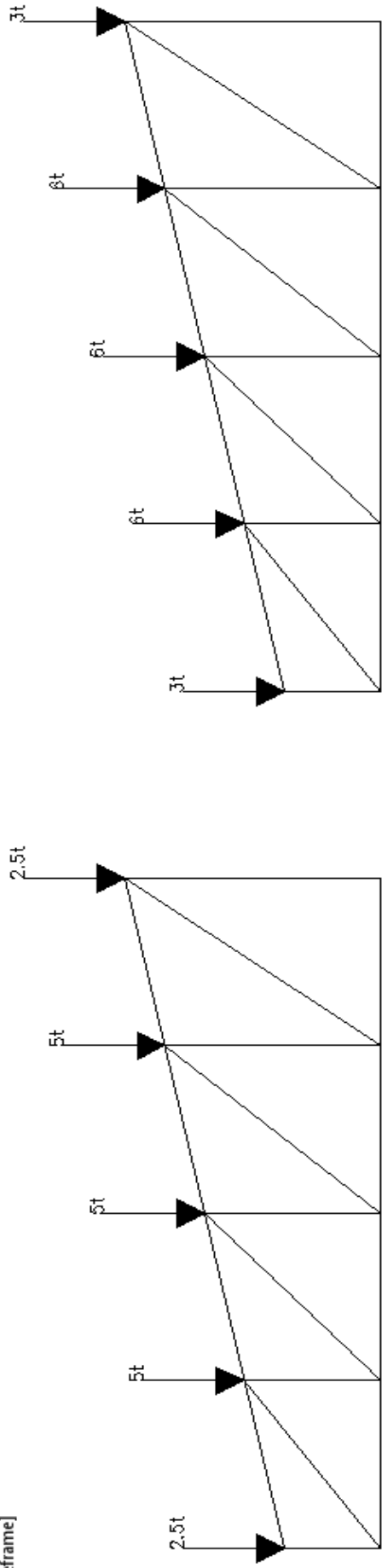

DEAD LOAD

LIVE LOAD

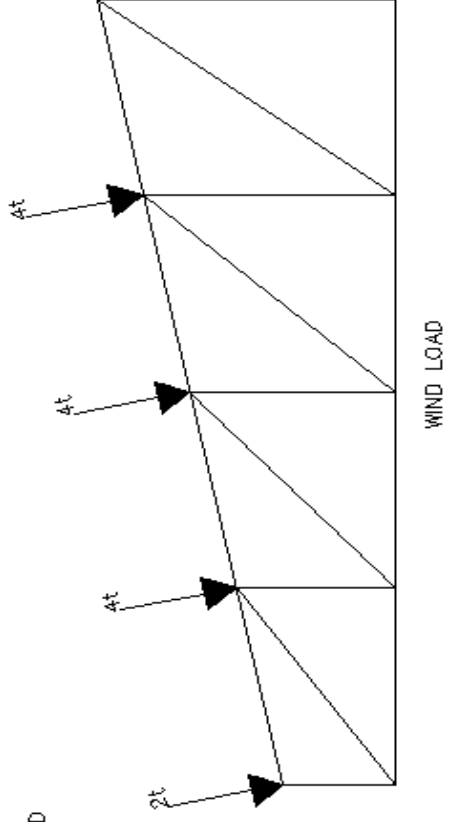

WIND LOAD

<

Material

Steel $\gamma = 7.85$ $\mu = 0.29$ $E = 2100000$

Sections

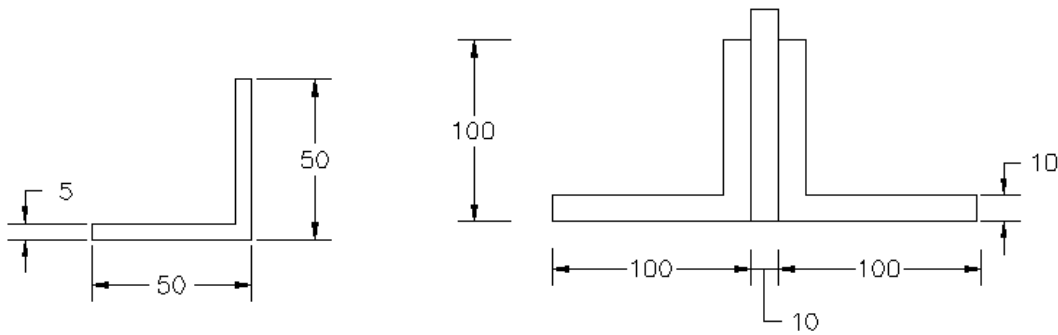

Req

N.F.D in Case DL+LL+WL

Solution

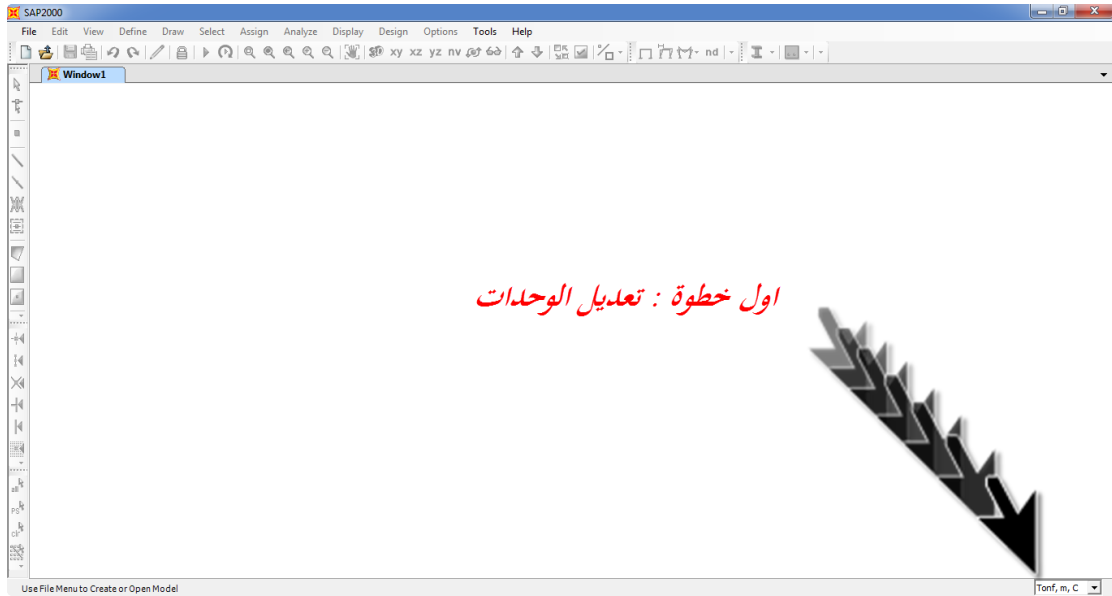

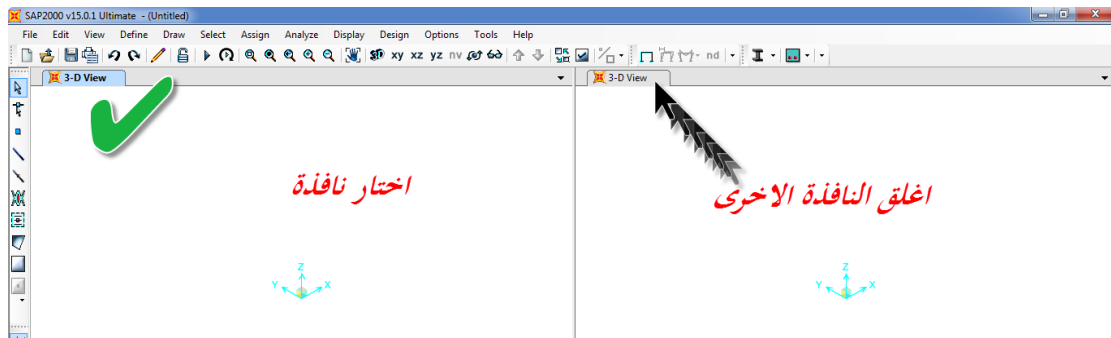
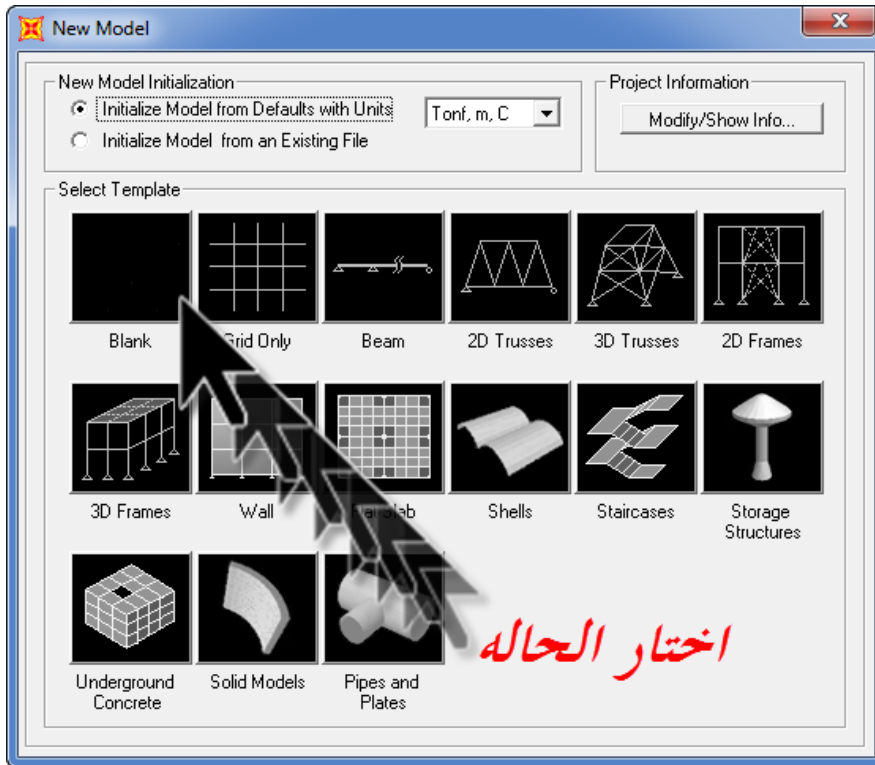
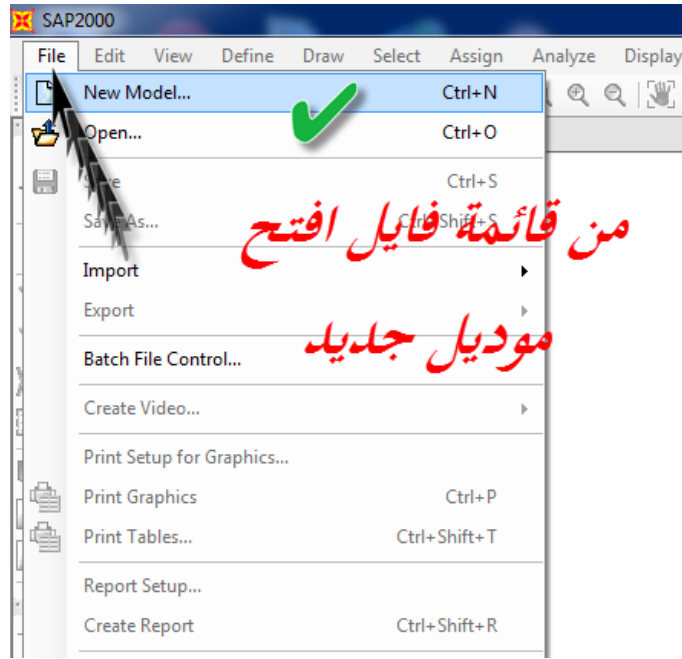



اختيار المستوى

كليك يمين في اي مكان على المستوى واختار

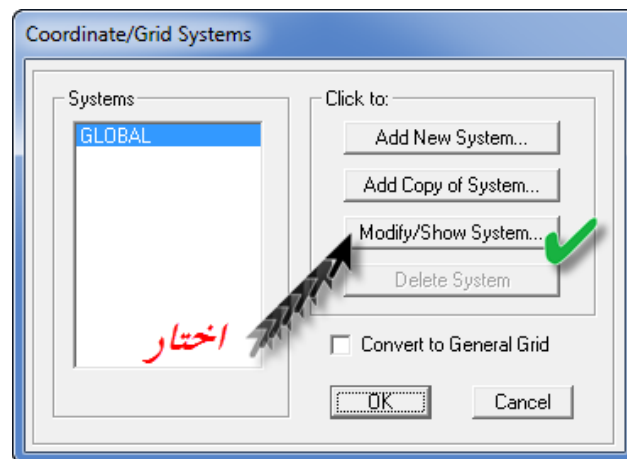
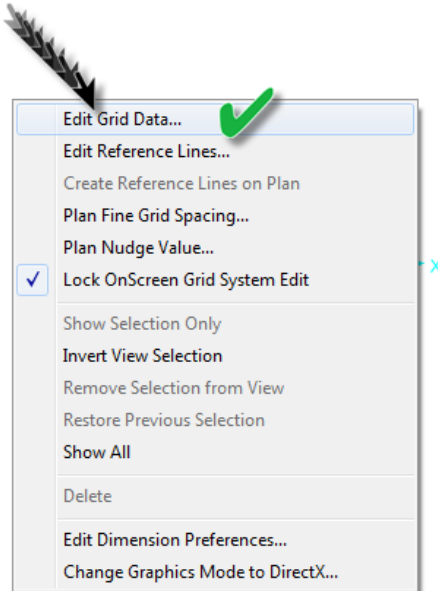

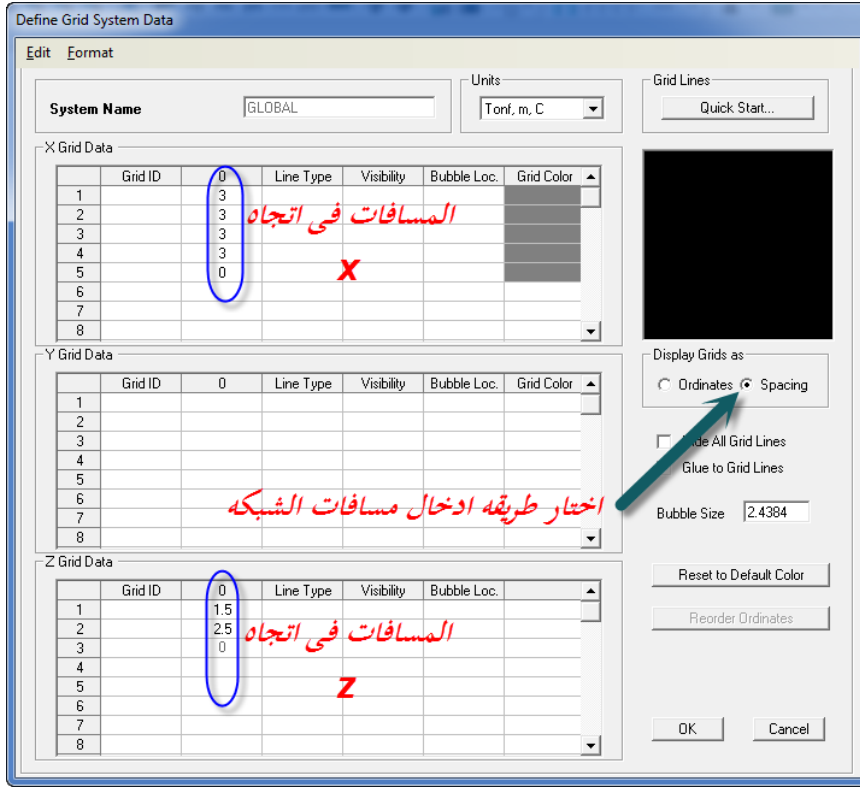

شكل شبكة المسافات المكونه



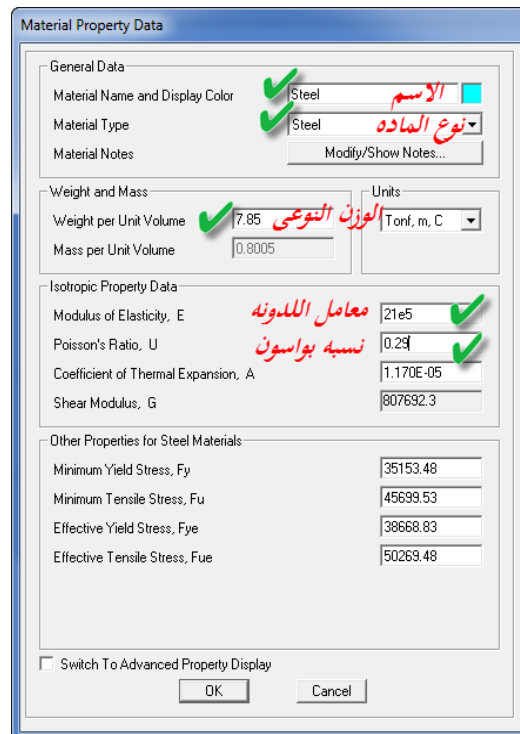
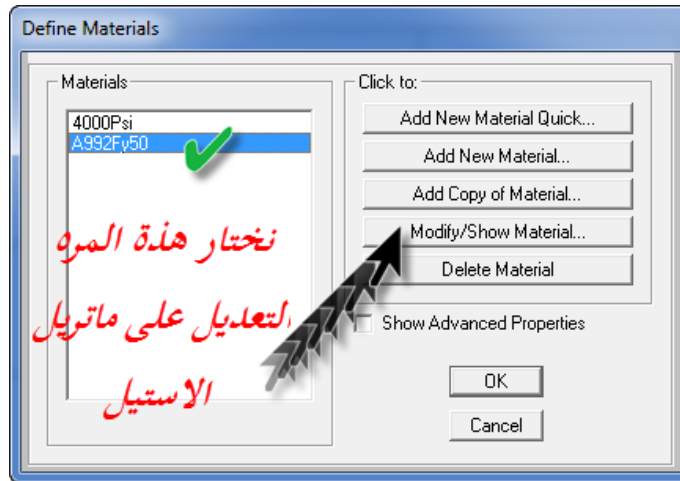
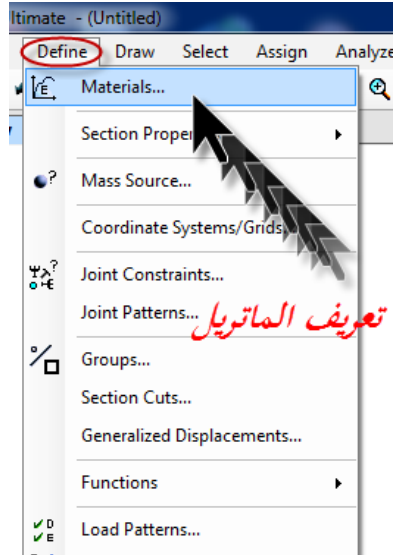

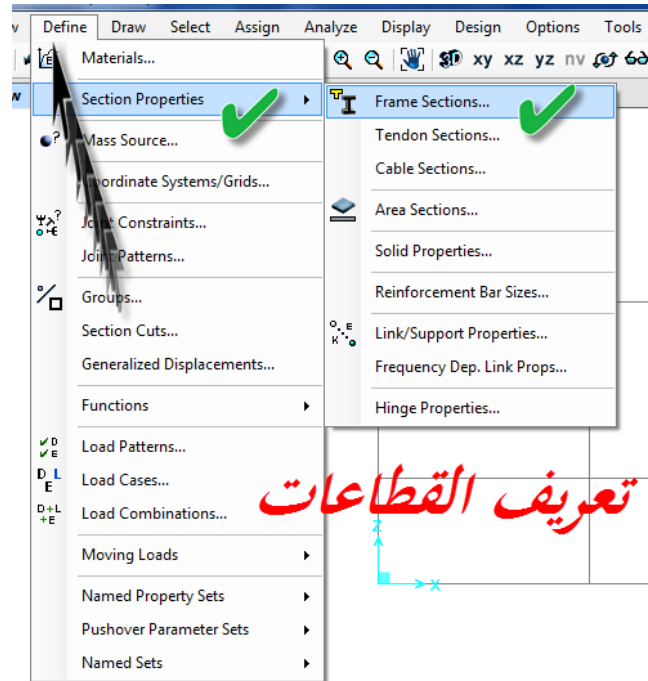

تعريف القطاعات

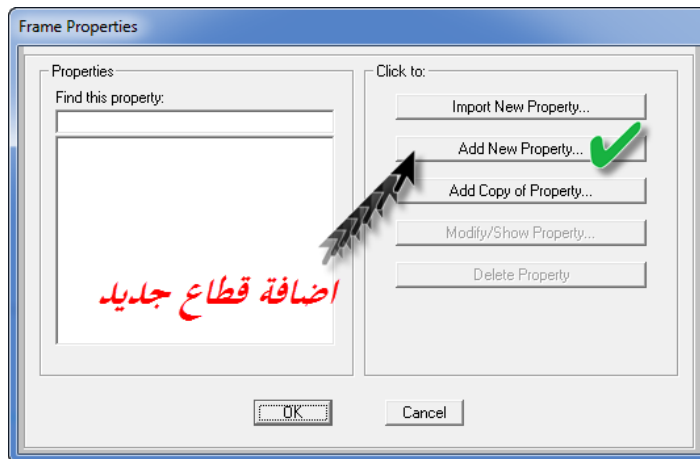

اضافة قطاع جديد



اختار قطاع زاوية واحده

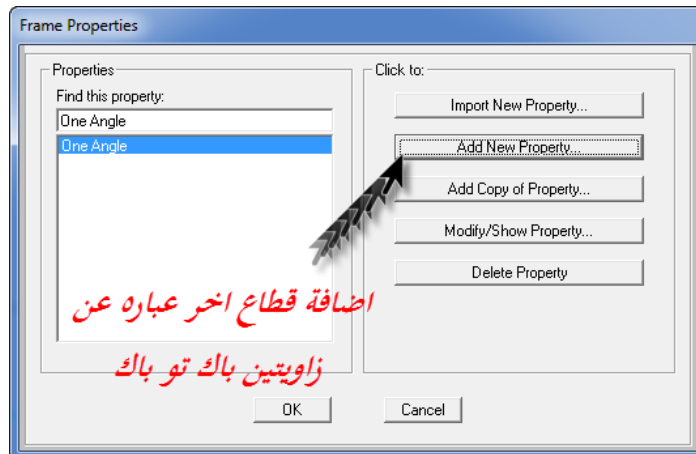
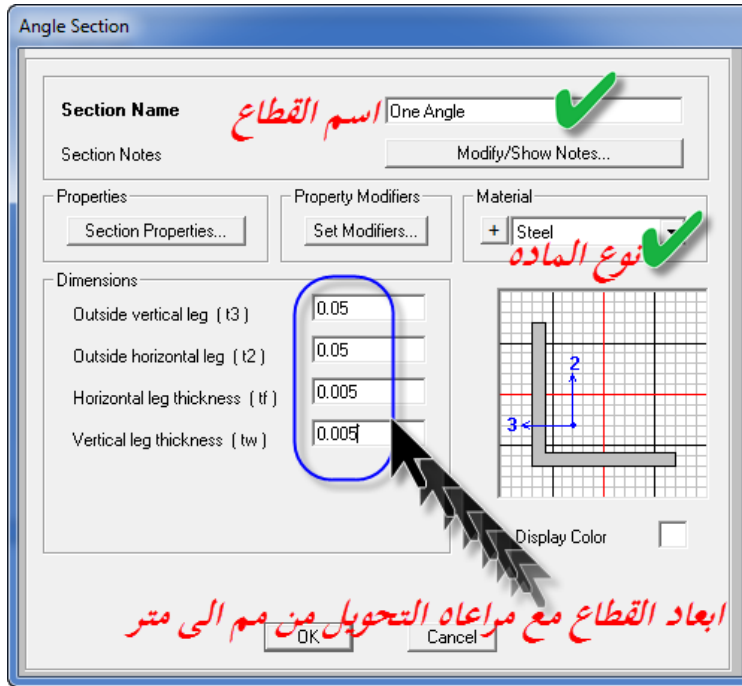

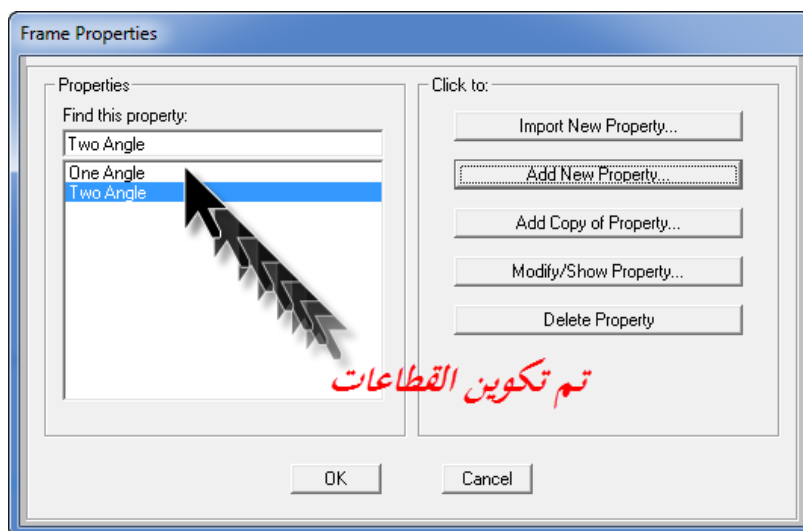
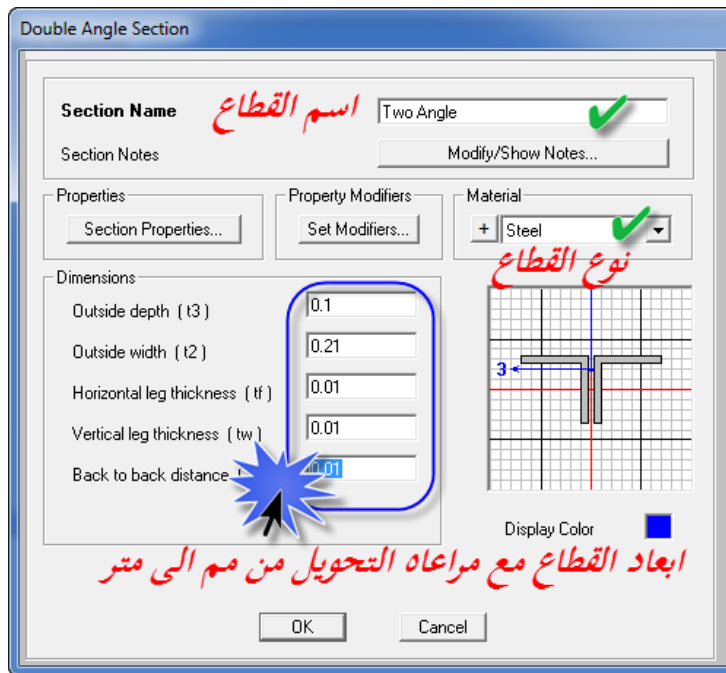

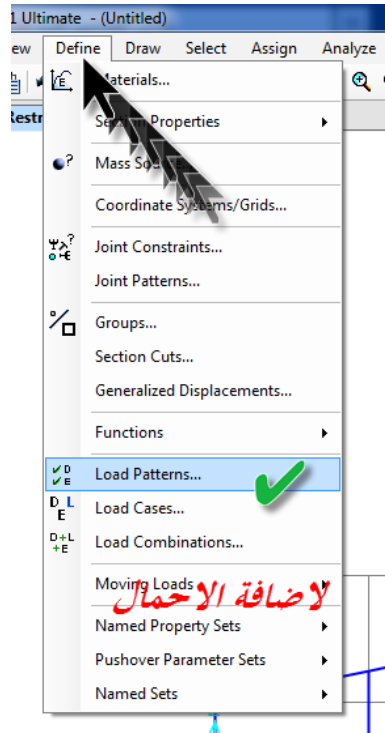

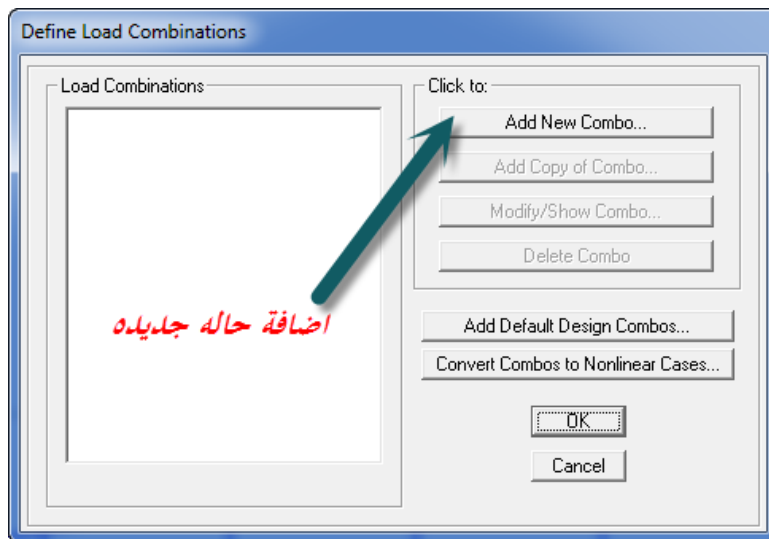
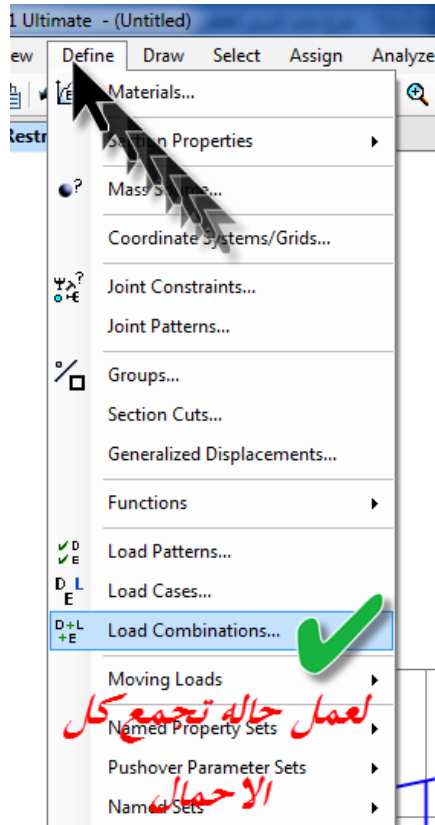

Load Combination Data

Load Combination Name (User-Generated) *اسم حالة الاحمال الجديده* DL+LL+WL

Notes

Load Combination Type *نوع جمع الاحمال* Linear Add

Options

Define Combination of Load Case Results

Load Case Name	Load Case Type	Scale Factor
wL ✓	Linear Static	1
DEAD	Linear Static	1
LL	Linear Static	1
wL <i>اختار الحمل</i>	Linear Static	1

هنا واضغط

اضافه

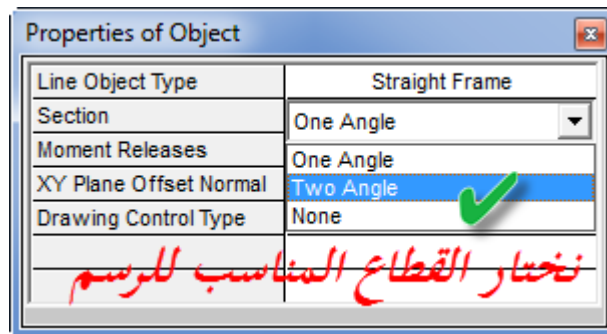
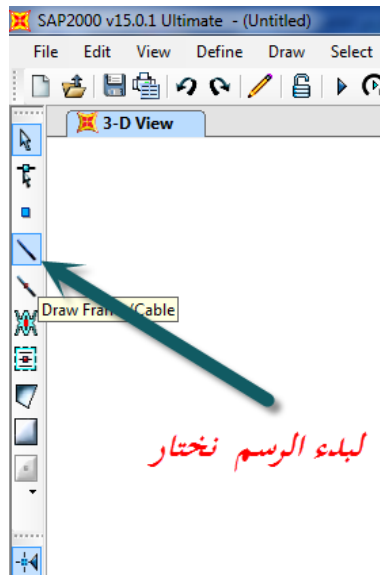
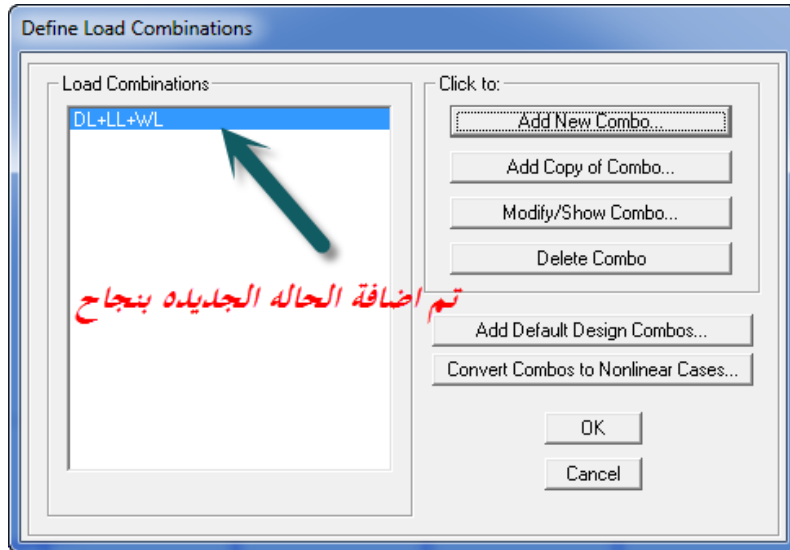

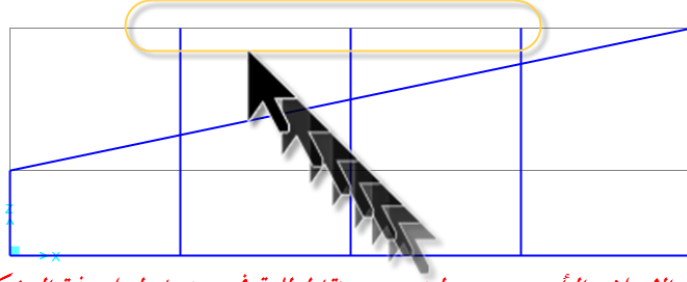

تم رسم الاضلاع الرأسية مستمرة لعدم وجود نقاط للوقوف عندها ولحل هذه المشكلة نلاحظ ذلك في الخطوات التالية

نقوم بتحديد الاضلاع المراد ايجاد نقاط عندها

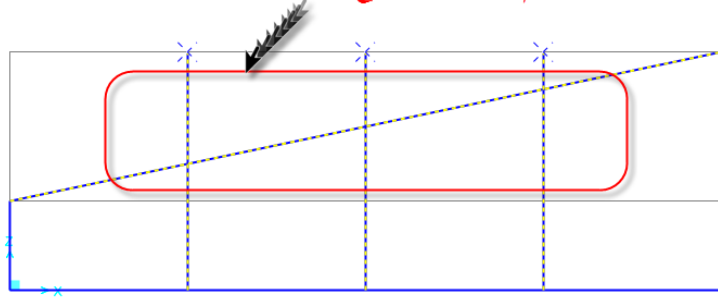

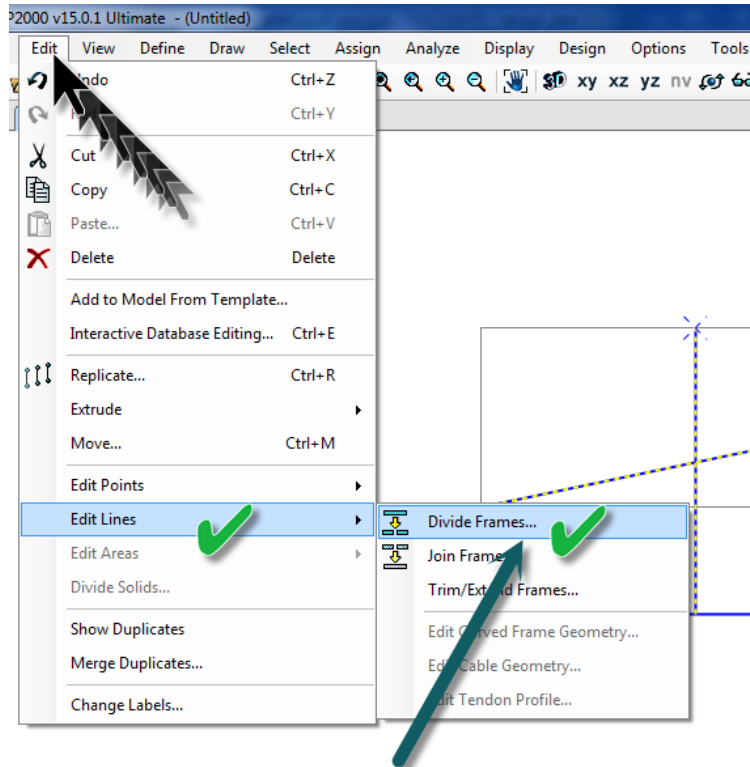

لتقسيم الاضلاع المحدده سابقاً

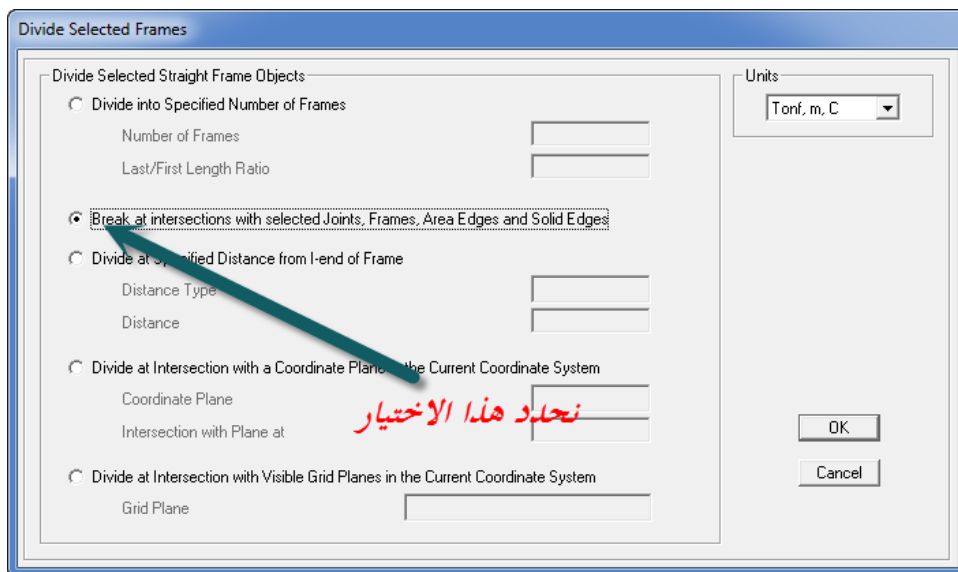

نلاحظ بعد التقسيم وجود نقاط للوقوف عندها

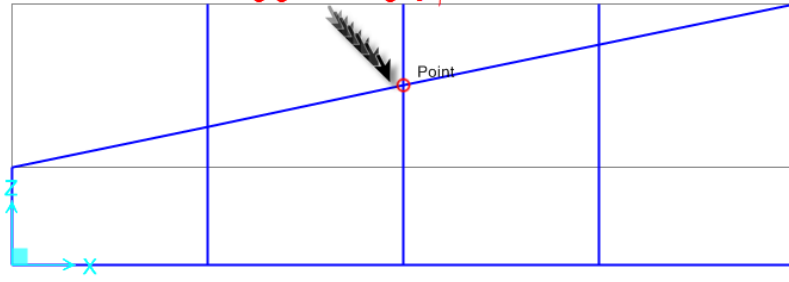

نقوم بعد ذلك بتحديد الاضلاع الزائده ومسحها باستخدام الامر

Delete

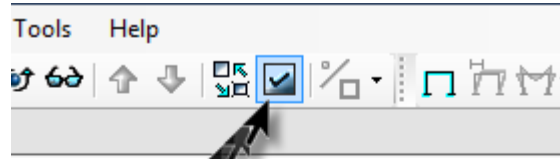
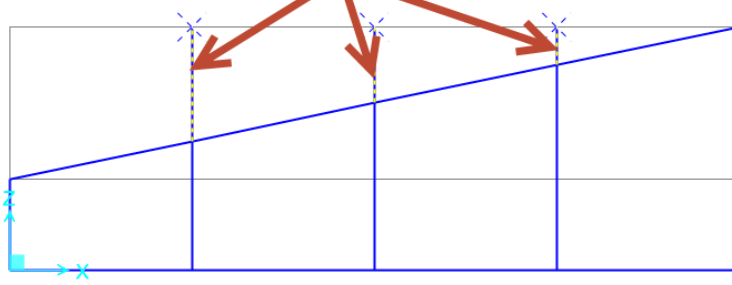

للتأكد من رسم كل ضلع بالقطاع
الخاص به

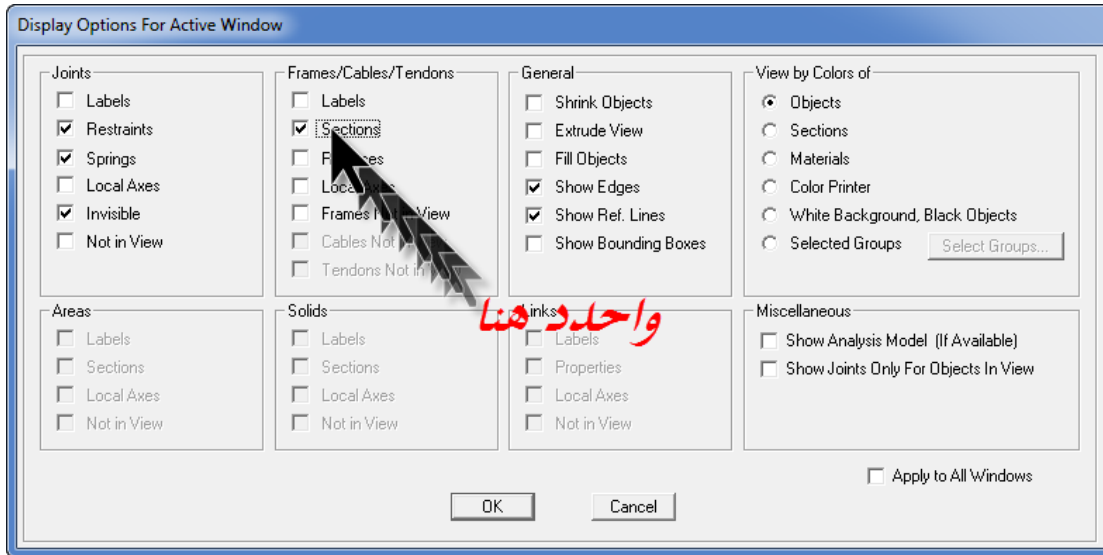

الاضلاع العلويه والسفليه مرسومه بالقطاع الزاويتين
والاضلاع الرأسية والمائله مرسومه بالقطاع الزاويه الواحده

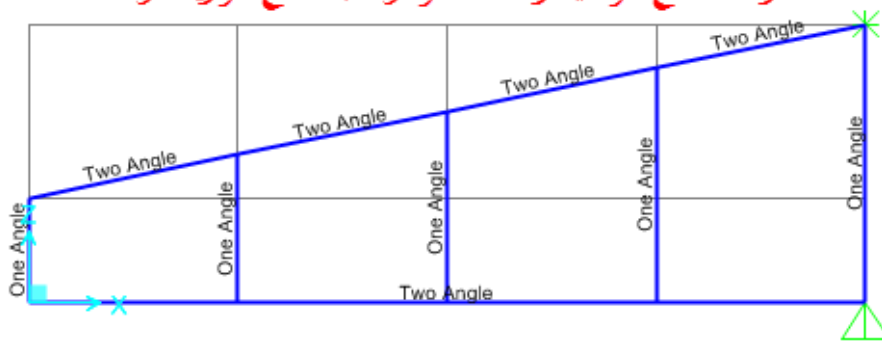

لاضافة الركيزة احدد النقطة عندها

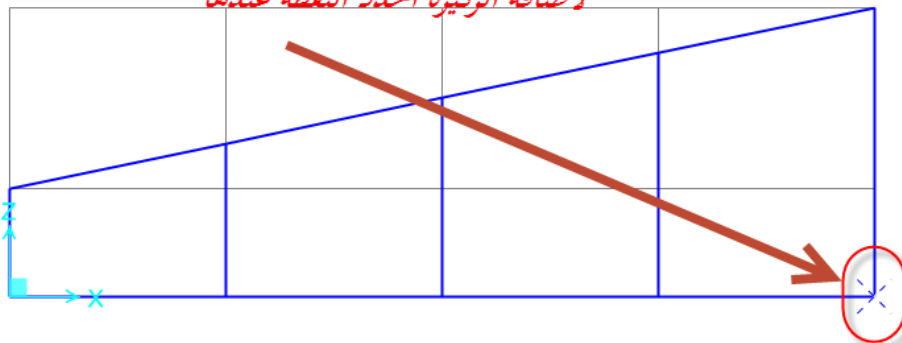

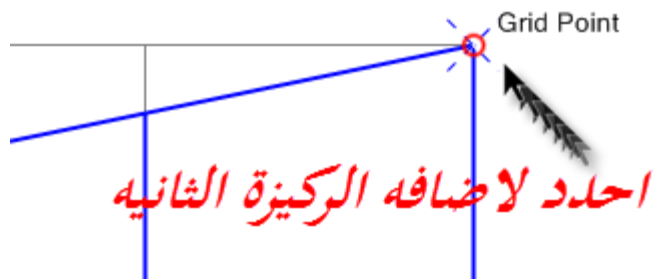
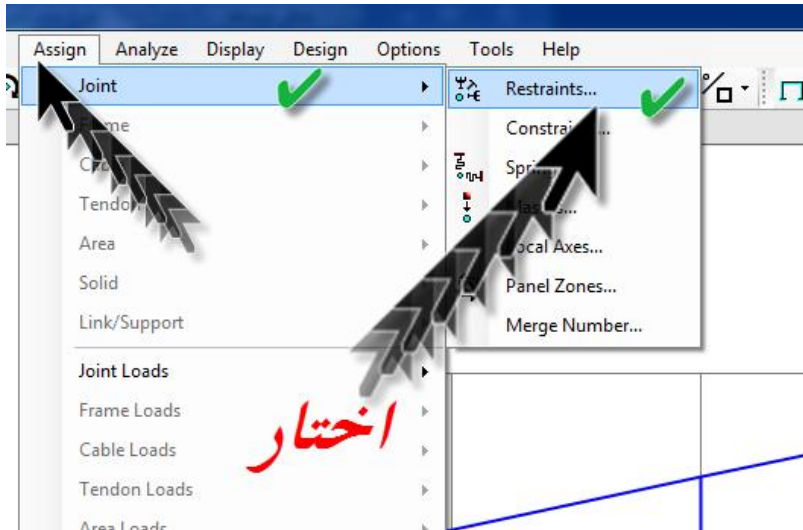

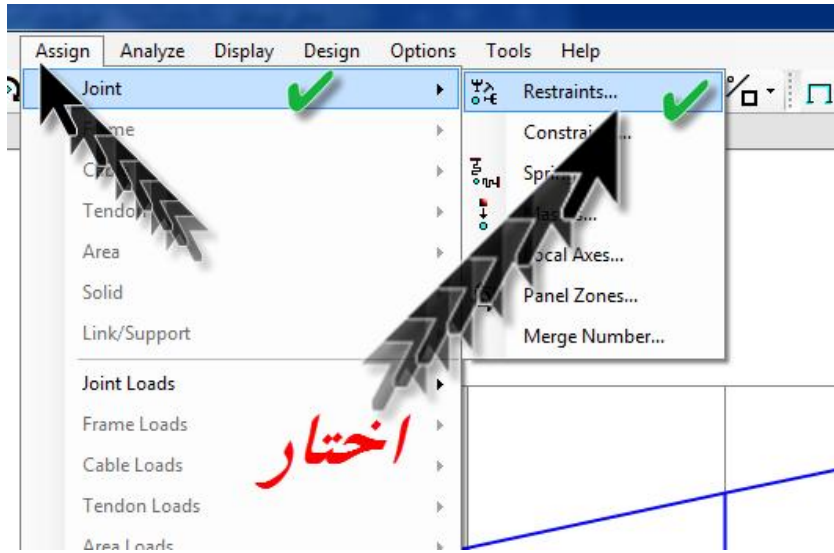

اختار نوع الركنية مع

مراعاة اختيار اتجاه

تأثيرها



في هذه الحالة الركنية

لا تمنع الحركة في

اتجاه محور

X

وانما تمنعها في اتجاه

محور

Z



تم اضافة الركيزة بهذا الشكل

اقوم بالتحديد على التراس بأكمله لعمل فصل لكل ضلع فيه لوضع الاحمال على مكان

الارتباط بين الاضلاع وليس على الاضلاع

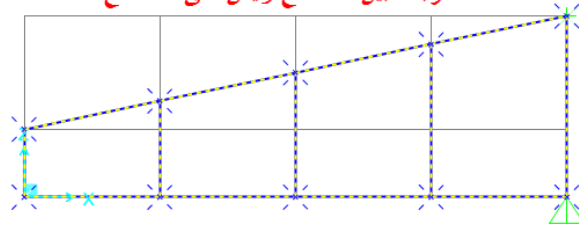

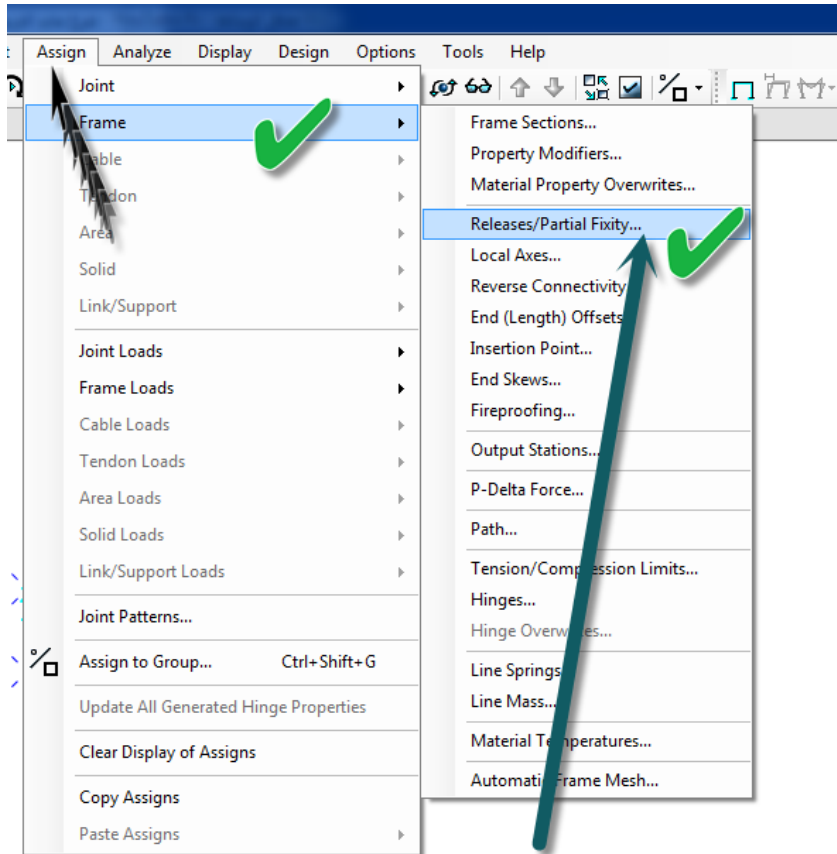

اختيار

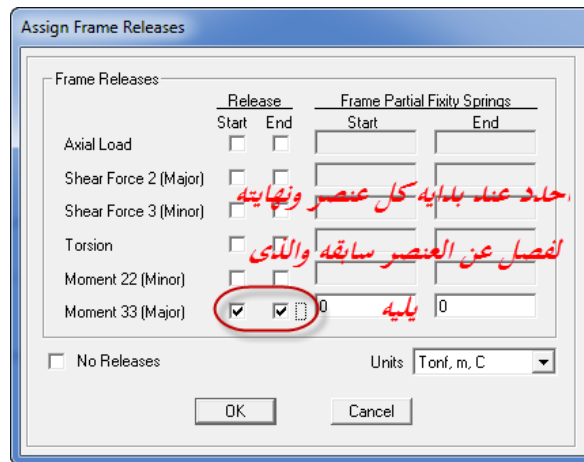

الشكل بعد التقسيم

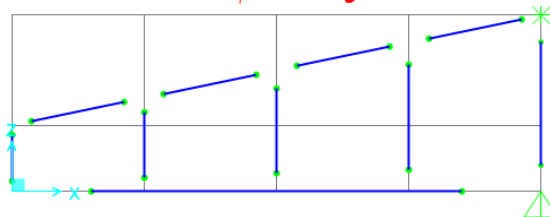

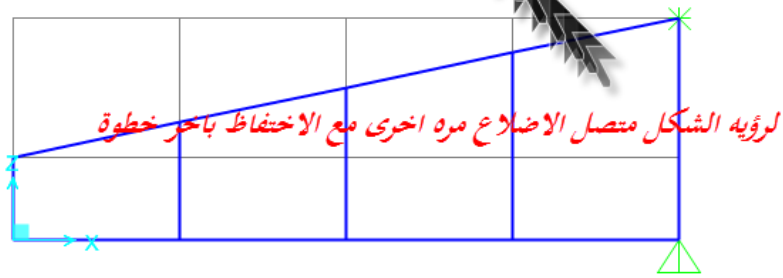
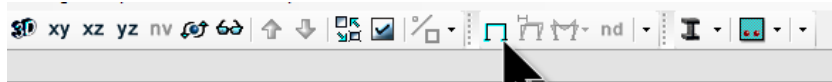

لاضافة الاحمال الميتة احدد على مكان الحمل

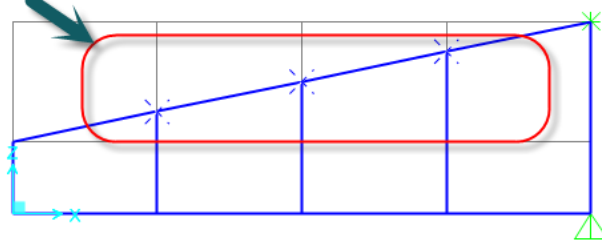

Joint Forces

Load Pattern Name: + DEAD **نوع الحمل**

Units: Tonf, m, C

Coordinate System: GLOBAL

Options:
 Add to Existing Loads
 Replace Existing Loads
 Delete Existing Loads

مع مراعاة الإشارة السالبة لتحديد اتجاه الحمل

تؤثر في اتجاه محور

Force Global X	Force Global Y	Force Global Z	Moment about Global X	Moment about Global Y	Moment about Global Z
0.	0.	-5	0.	0.	0.

OK Cancel

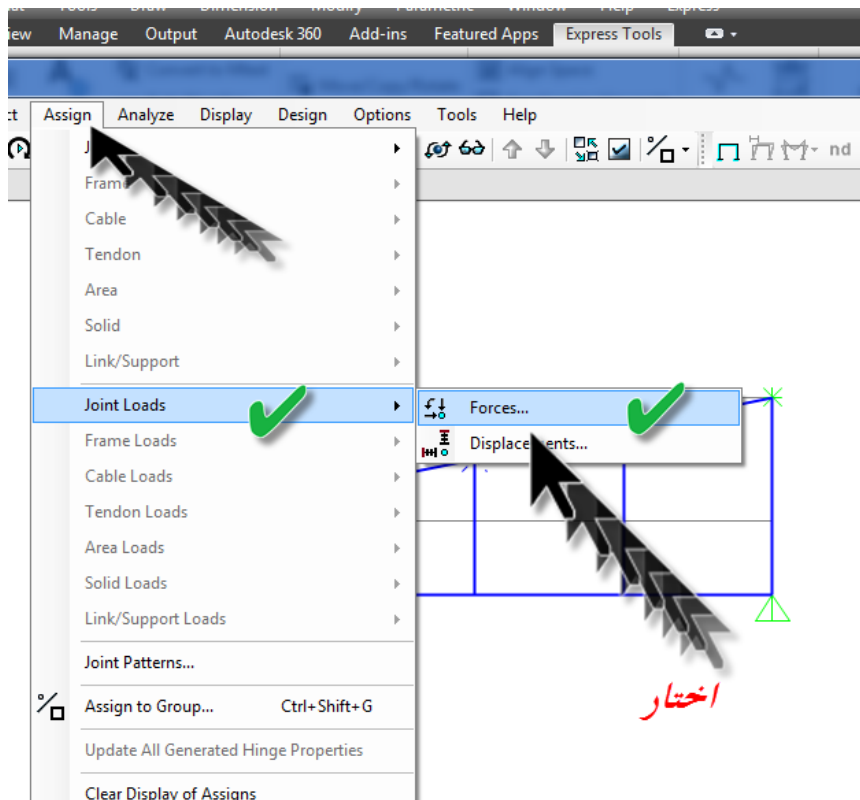
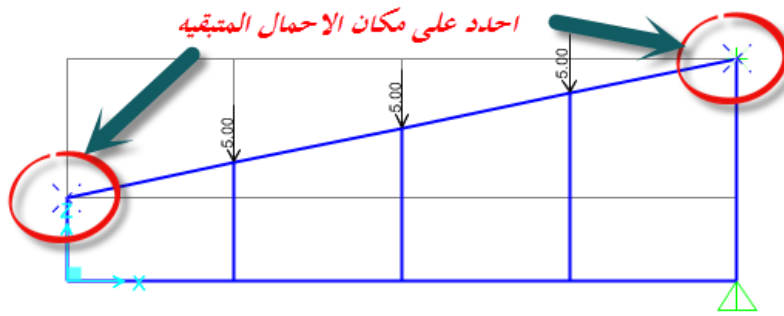

Joint Forces

Load Pattern Name: + DEAD نوع الحمل

Units: Tonf, m, C

Coordinate System: GLOBAL

Options:

- Add to Existing Loads
- Replace Existing Loads
- Delete Existing Loads

Loads:

Force Global X	0.
Force Global Y	0.
Force Global Z	-2.5
Moment about Global X	0.
Moment about Global Y	0.
Moment about Global Z	0.

قيمة الحمل واتجاهه

لاضافة الحمل الى الاحمال السابقة وعدم استبداله بها

OK Cancel

احدد على الاضلاع التي تؤثر الاحمال عند بداية كل منها

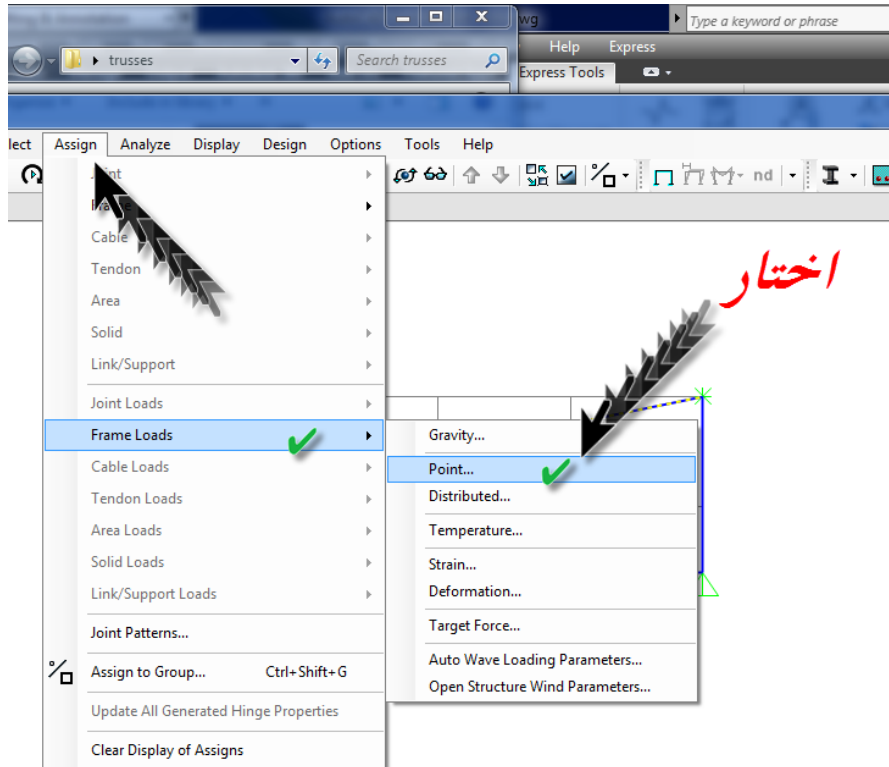
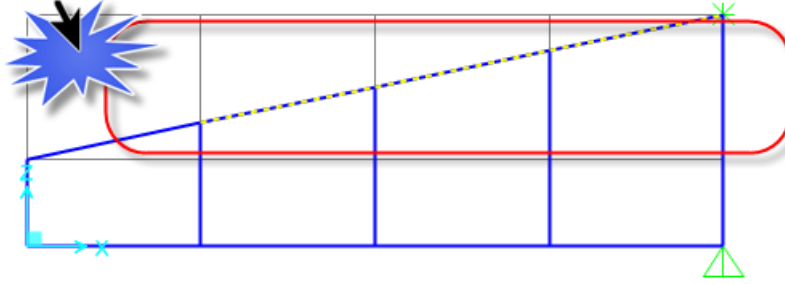

Frame Point Loads

Load Pattern Name: نوع الحمل

Units:

Load Type and Direction: Forces Moments

Coord Sys: المحليه

Direction: المحور 2

Options: Add to Existing Loads Replace Existing Loads Delete Existing Loads

Point Loads	1.	2.	3.	4.
Distance	<input type="text" value="0."/>	<input type="text" value="0.25"/>	<input type="text" value="0.75"/>	<input type="text" value="1."/>
Load	<input type="text" value="-4."/>	<input type="text" value="0."/>	<input type="text" value="0."/>	<input type="text" value="0."/>

Relative Distance from End-I Absolute Distance from End-I

قيمة الحمل عند بداية كل ضلع
والاشاره السالبة لتحديد الاتجاه

OK Cancel

وبالمثل اضافة الاحمال الحيه

لاضافه احمال تأثير الرياح العموديه

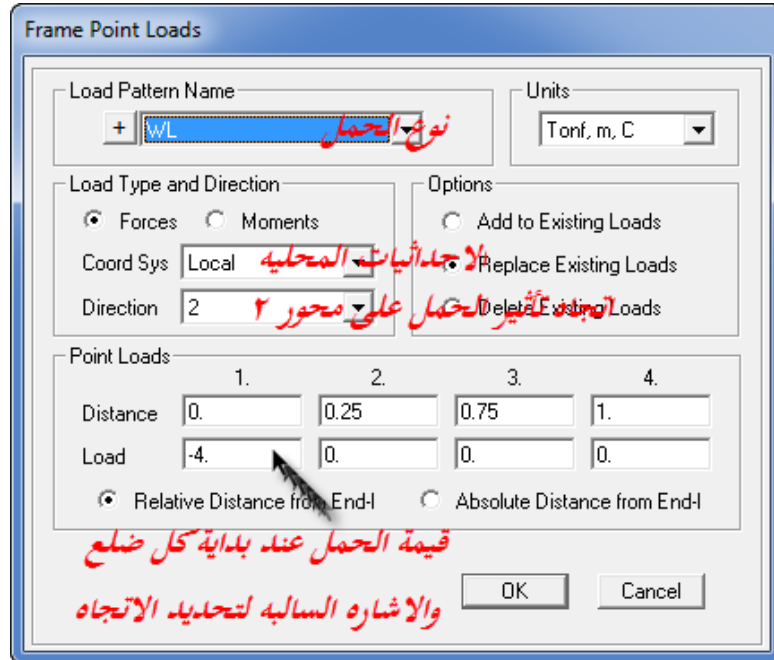
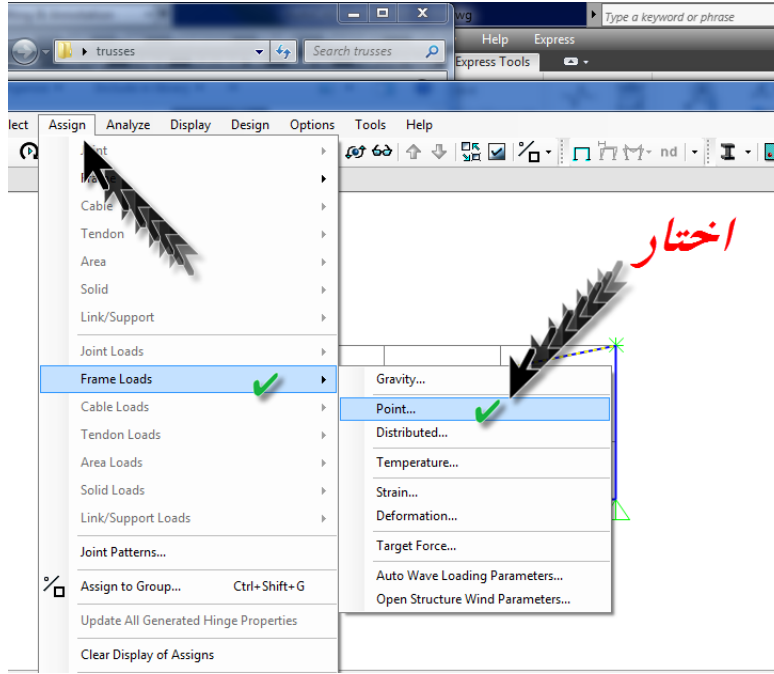

الاحمال المضافة عمودياً على الاضلاع العلوية للتراس

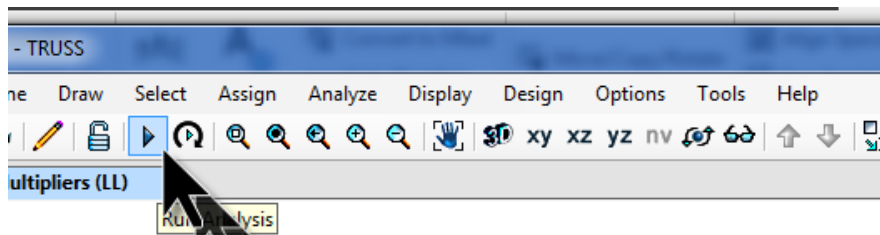
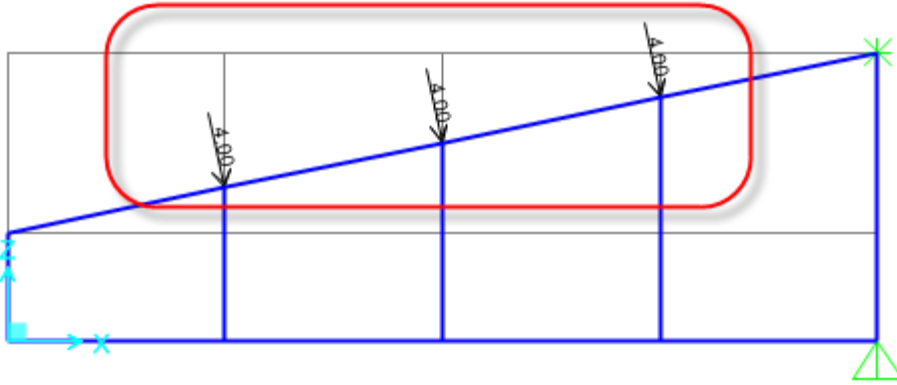

قوم باجراء التحليل الانشائي الان

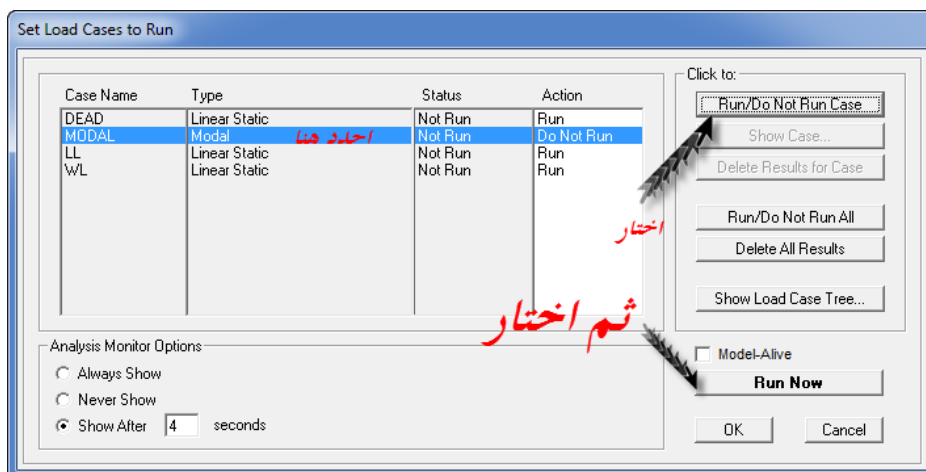

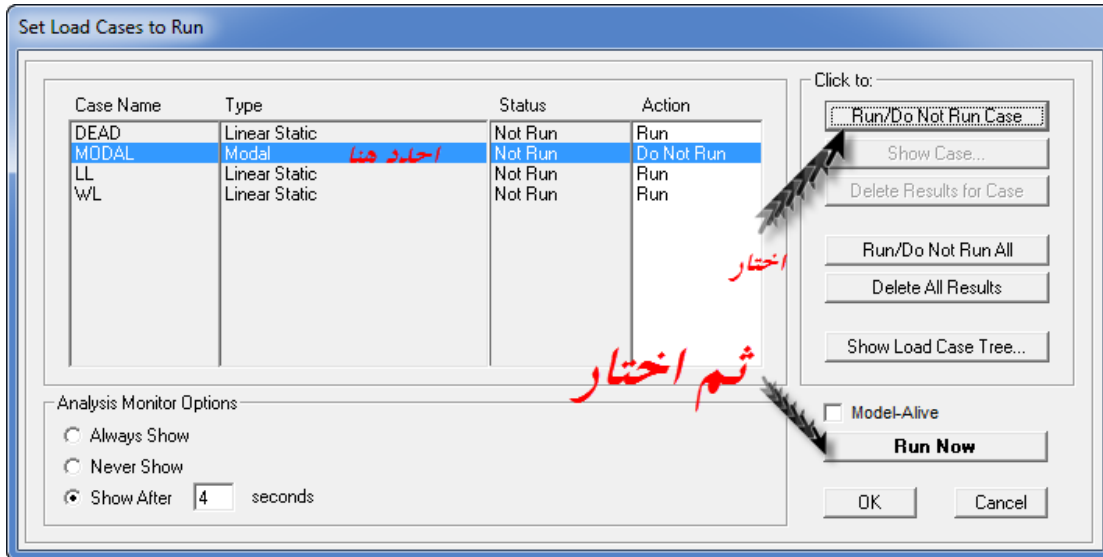

شكل التراس نتيجة وجود الاحمال عليه

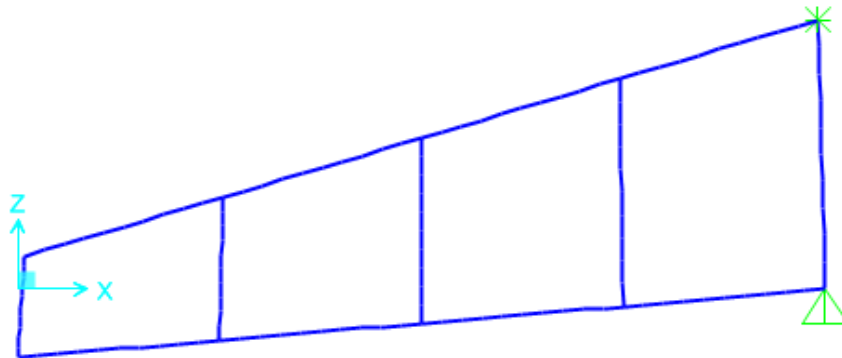

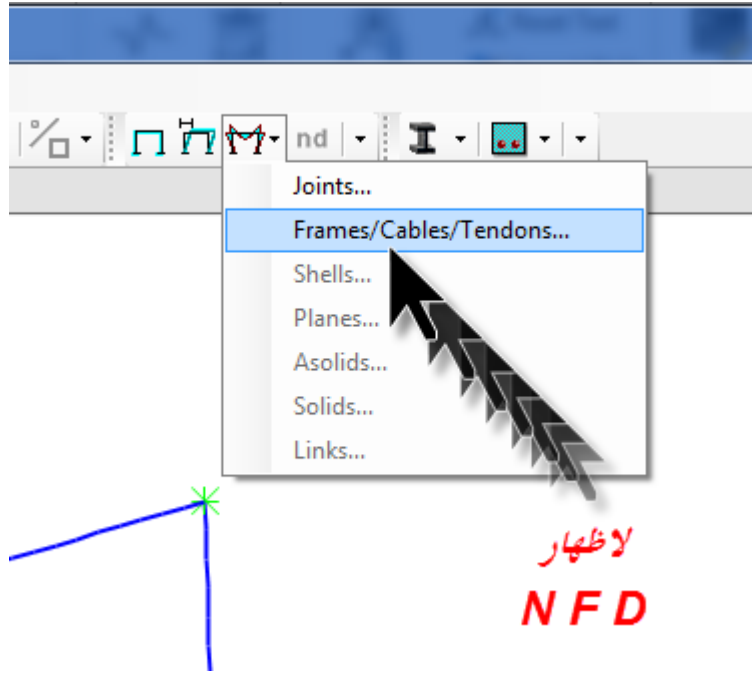

الشكل النهائي
NFD
في حالة
DL+LL+WL

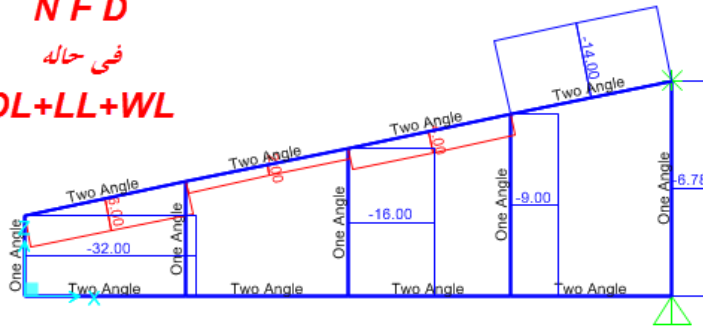

بِسْمِ اللَّهِ الرَّحْمَنِ الرَّحِيمِ
تَعْمِدُ عَلَى اللَّهِ

مسائل محلولة على برنامج الساب

إعداد

مهندس: خالد عبد الكريم

Eng.kh_ahmed@yahoo.com

01063366722 Or 01140506722

www.facebook.com/Eng.Khaled.Abdelkarim

Solid Slab

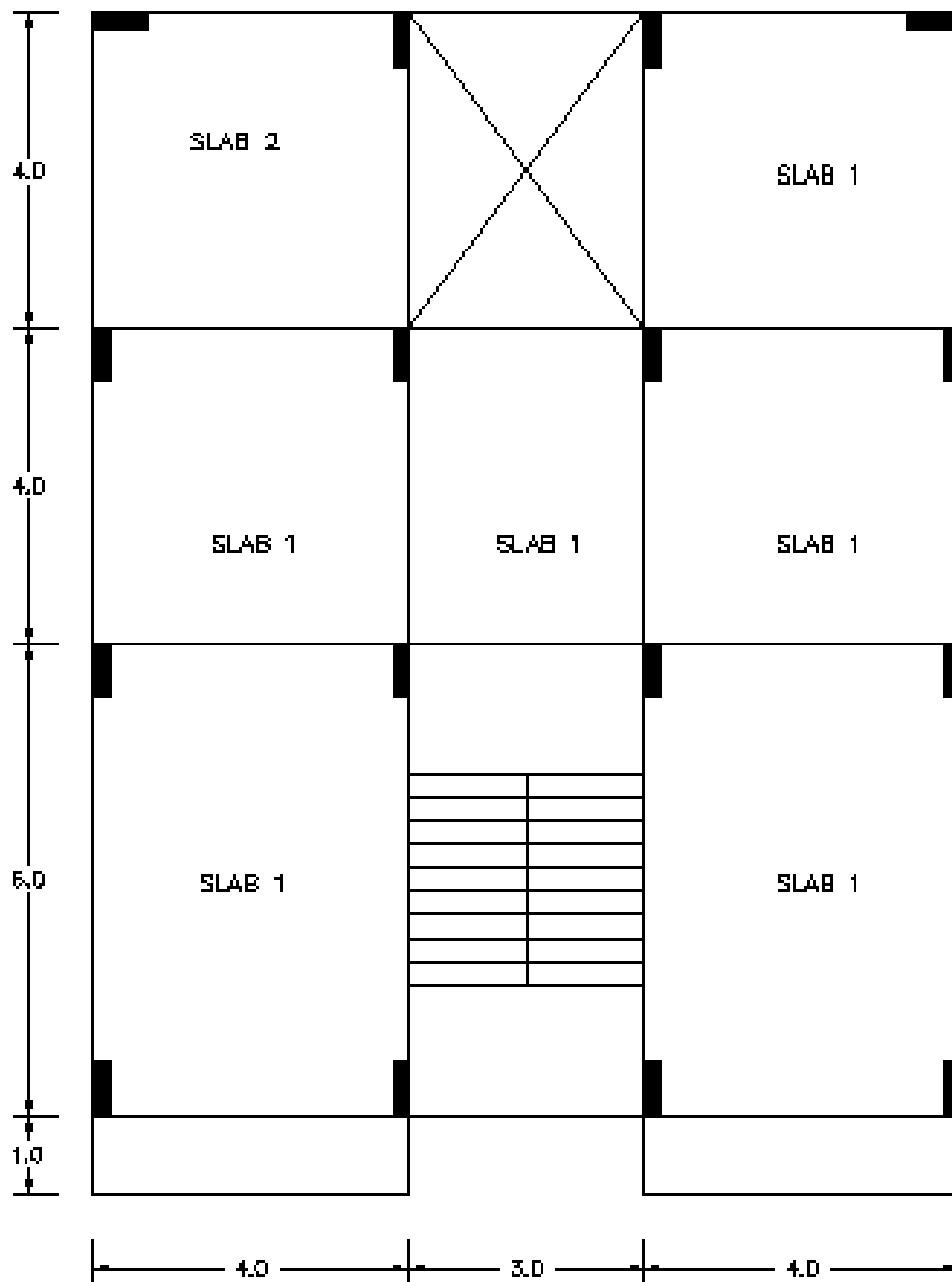

$$DL = 150 \text{ kg/m}^2$$

$$LL = 300 \text{ kg/m}^2$$

$$WL = h_w * t_w * Y_w$$

$$A_s = M_u / F_y * J * d$$

ALL BEAMS R 0.12*0.60 m

Slab 1 th = 15 cm

Slab 2 th = 10 cm

REQ :

BMD Of All Slabs And Calculate As

Solution

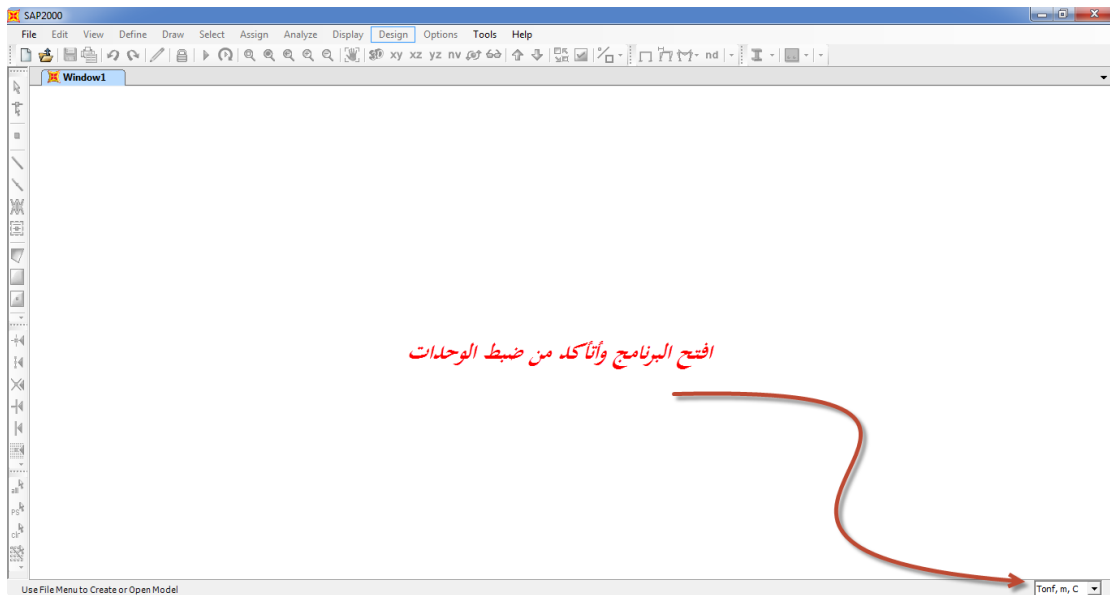

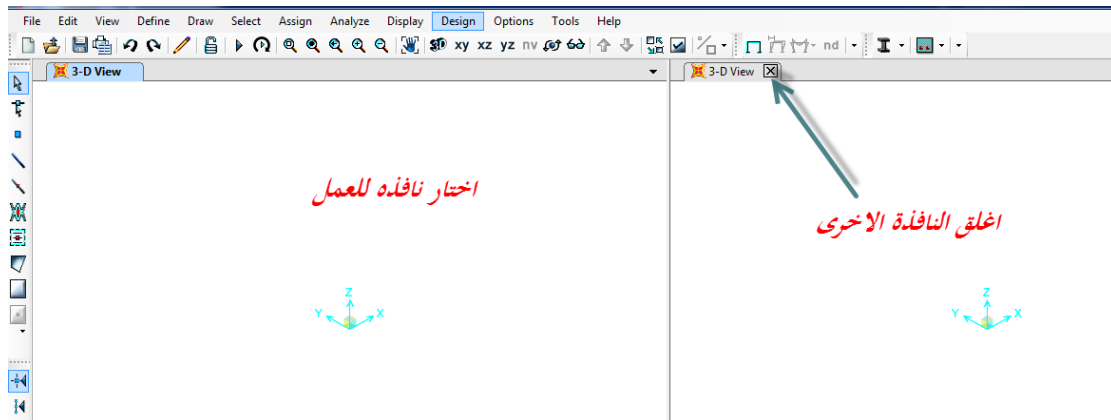
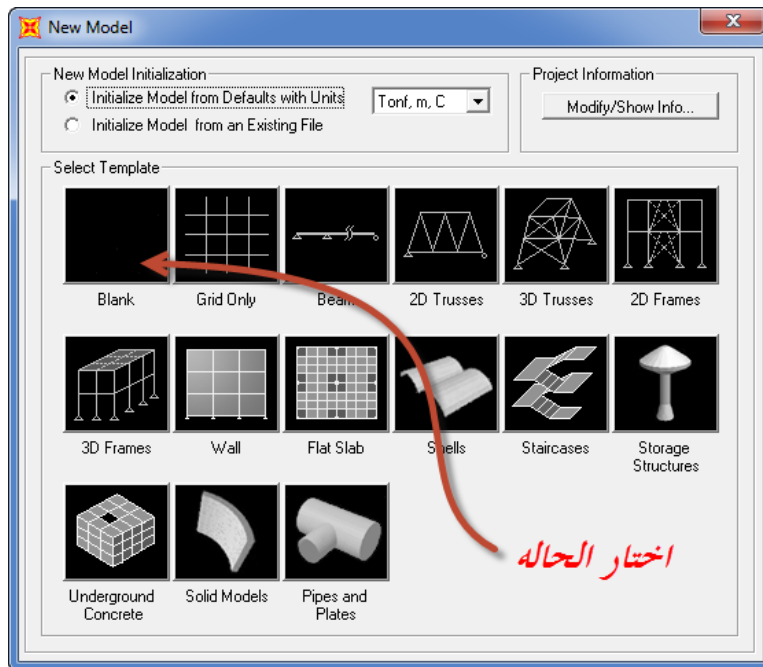
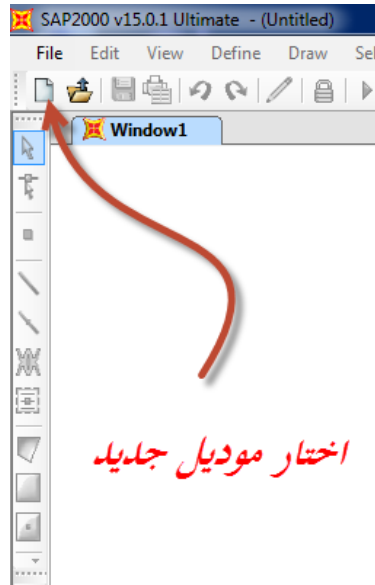

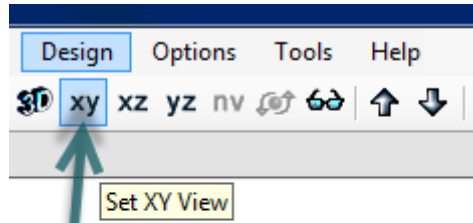

اختار مستوى العمل

كليك يمين في اي مكان على الشاشة واختار

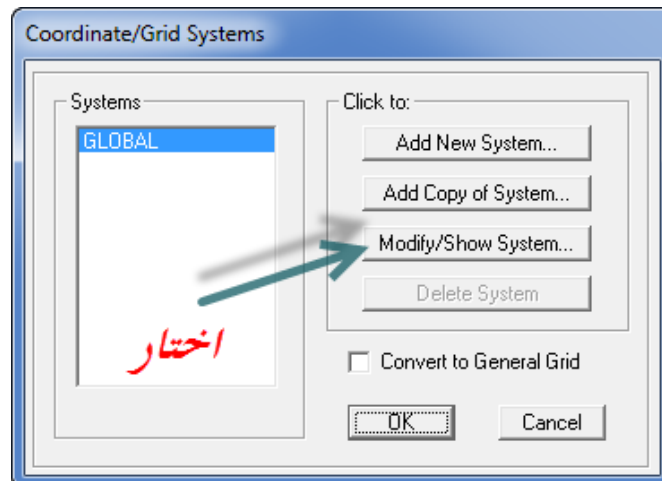
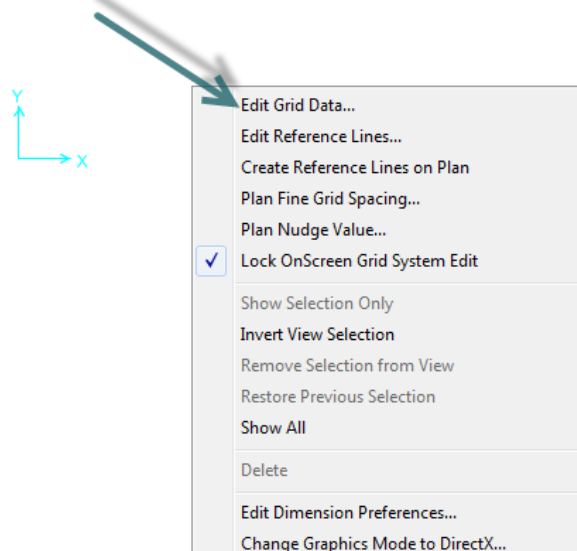

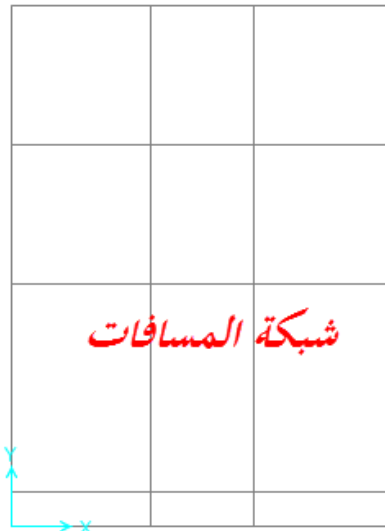
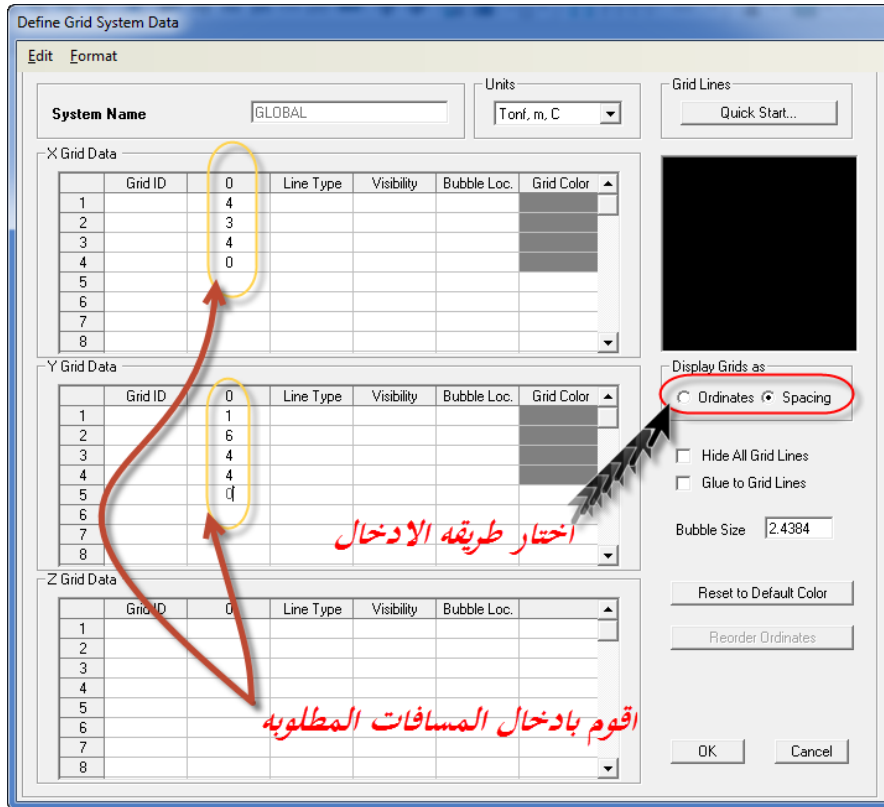

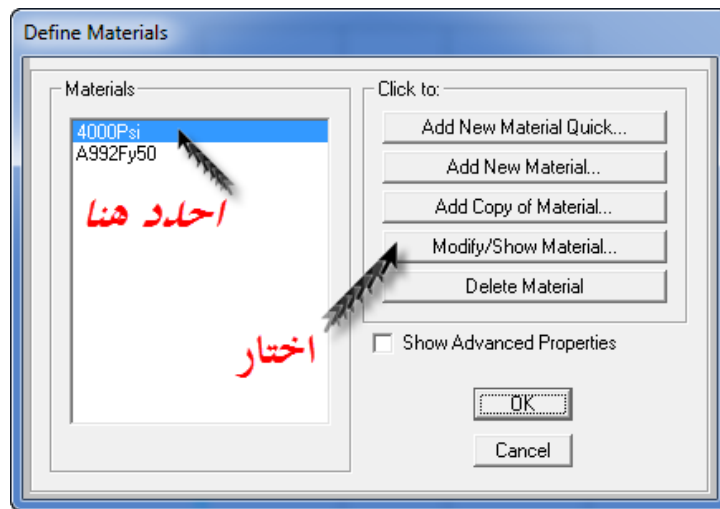
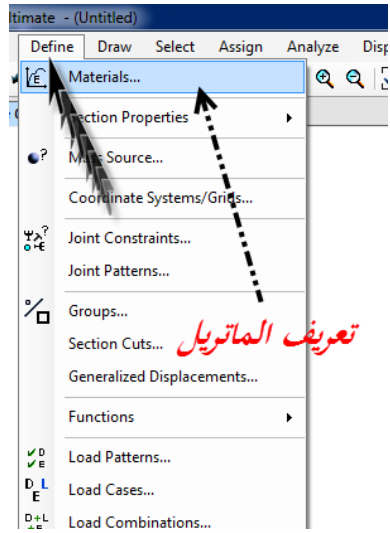

Material Property Data

General Data

Material Name and Display Color: RC **الاسم**

Material Type: Concrete **نوع المواد**

Material Notes:

Weight and Mass

Weight per Unit Volume: 2.5 **الجمام**

Mass per Unit Volume: 0.2549

Units: Tonf, m, C

Isotropic Property Data

Modulus of Elasticity, E: 2534563.6

Poisson's Ratio, U: 0.2

Coefficient of Thermal Expansion, A: 9.900E-06

Shear Modulus, G: 1056068.2

Other Properties for Concrete Materials

Specified Concrete Compressive Strength, f_c: 2812.2785

Lightweight Concrete

Shear Strength Reduction Factor:

Switch To Advanced Property Display

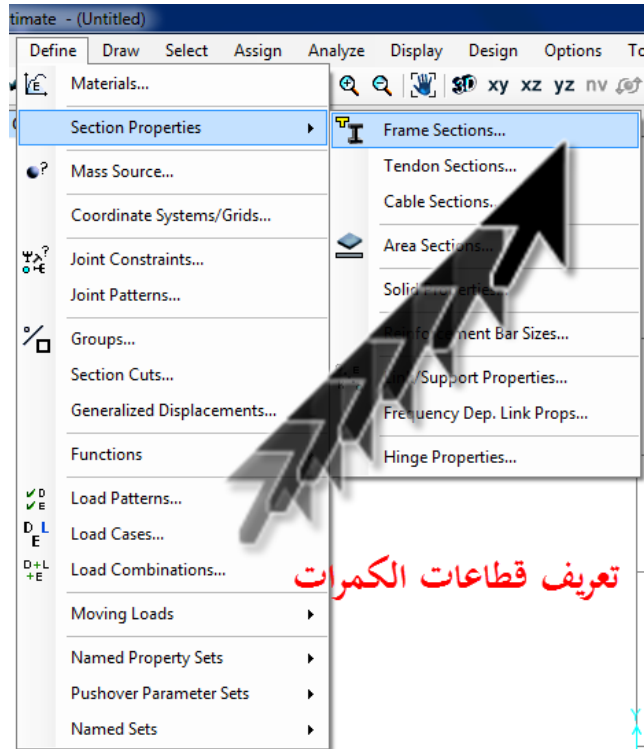

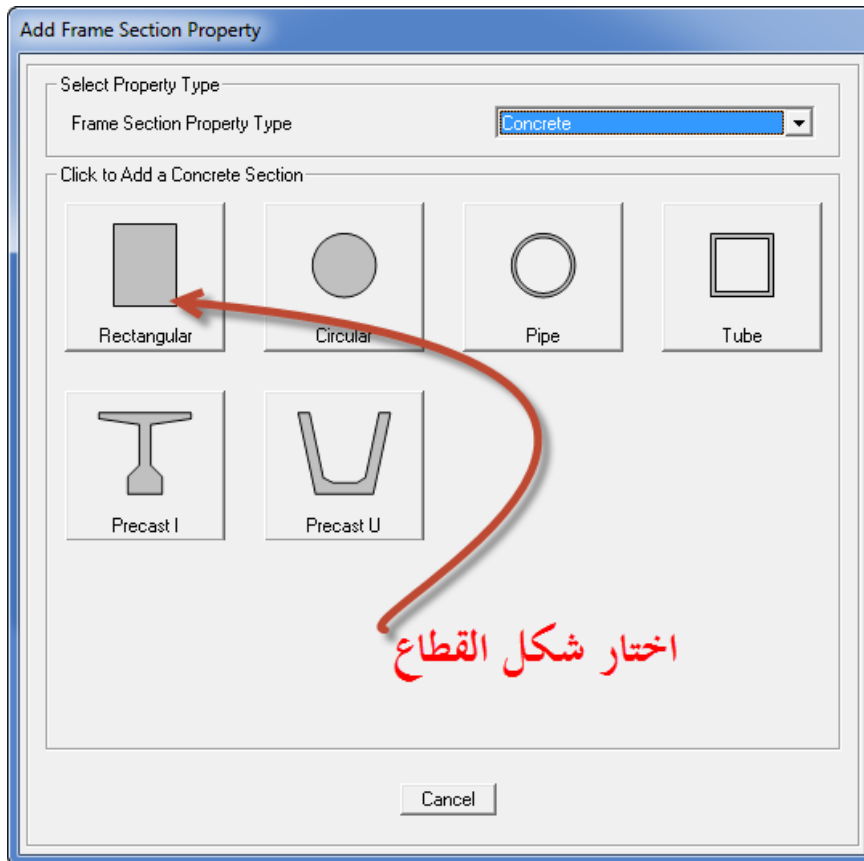
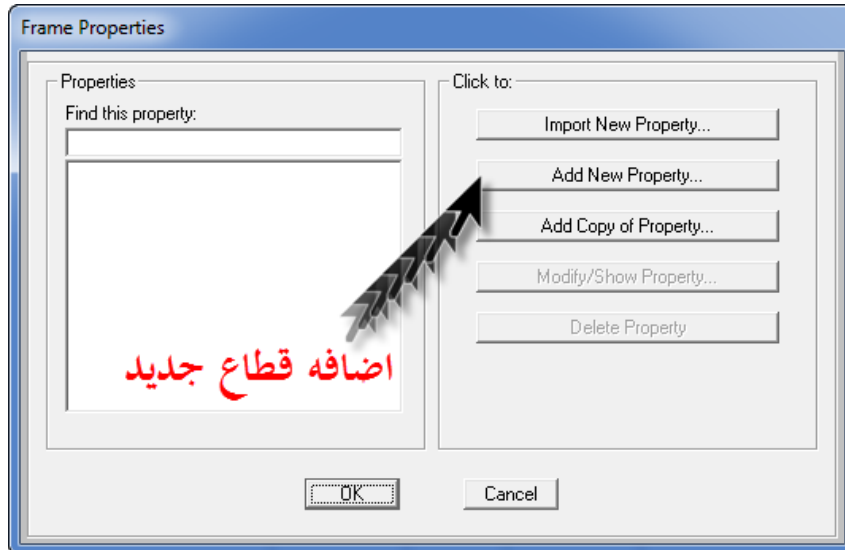

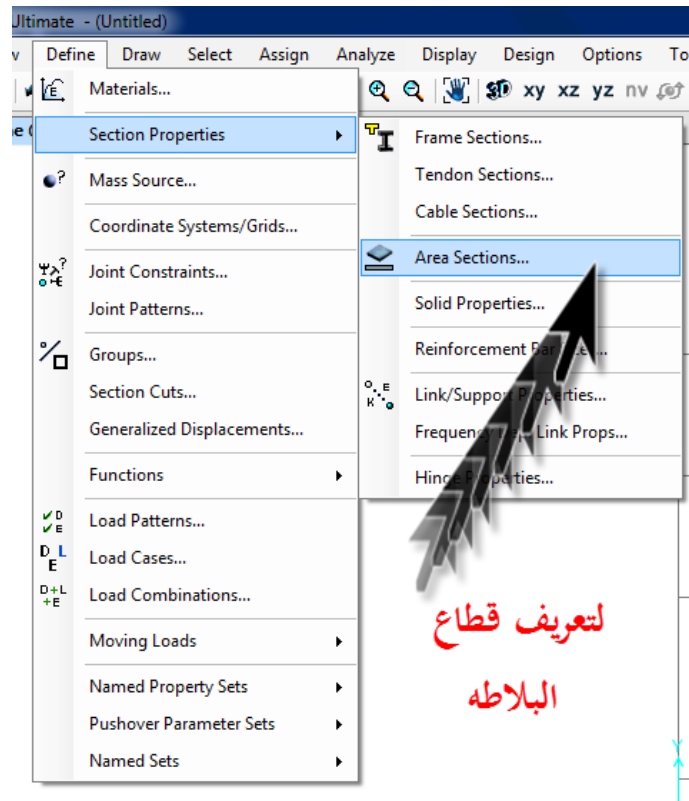
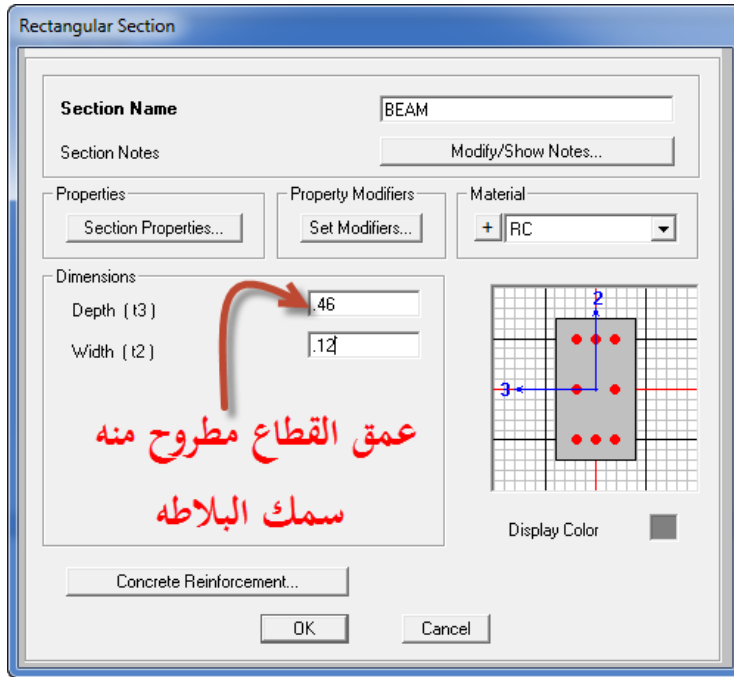

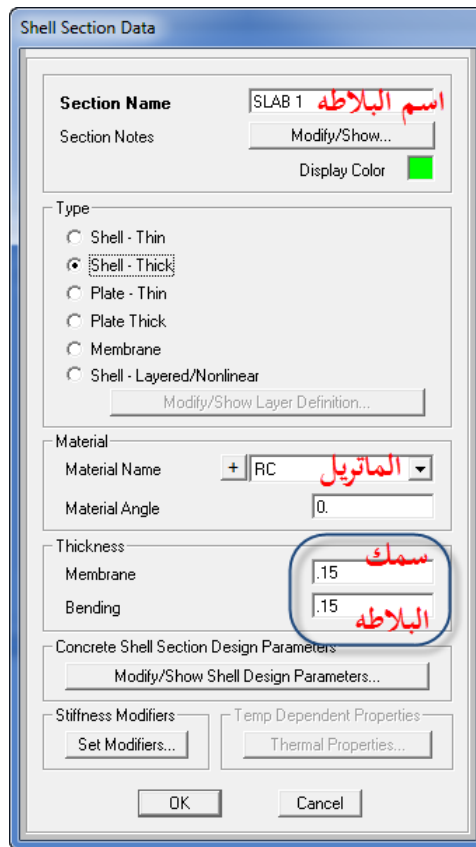
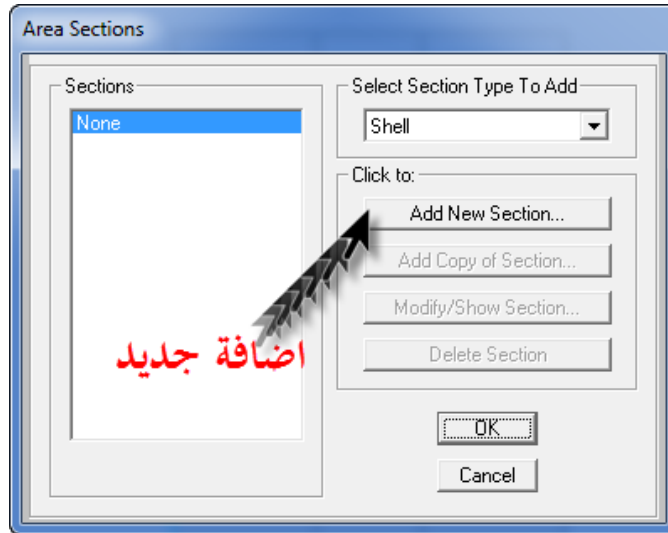

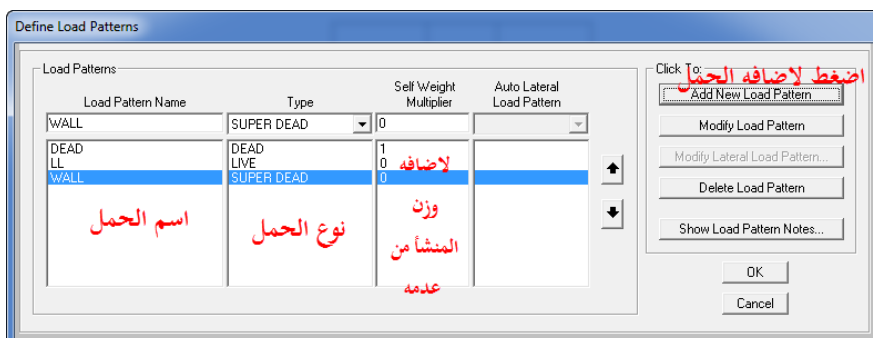
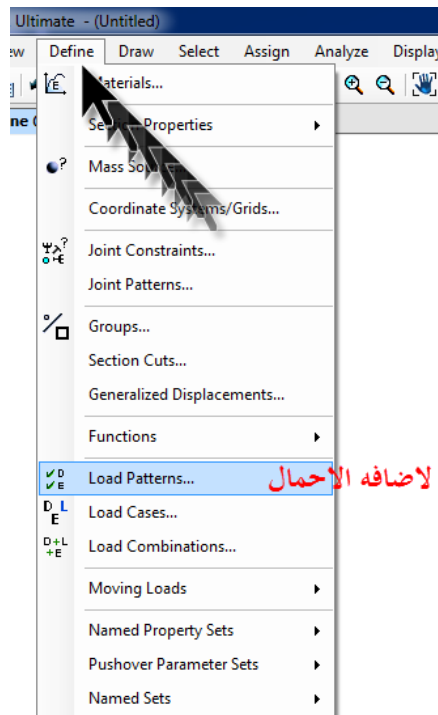
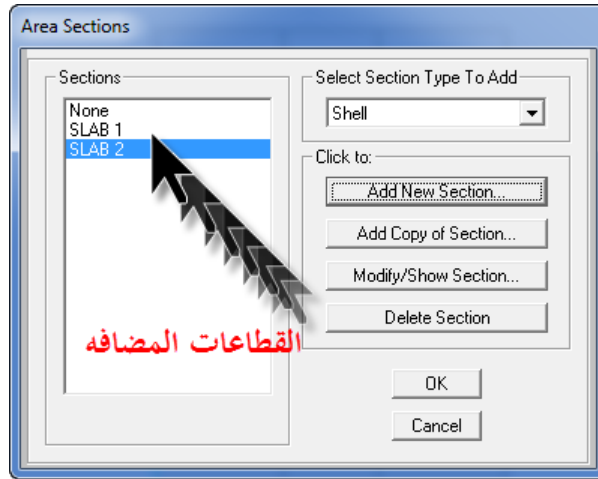

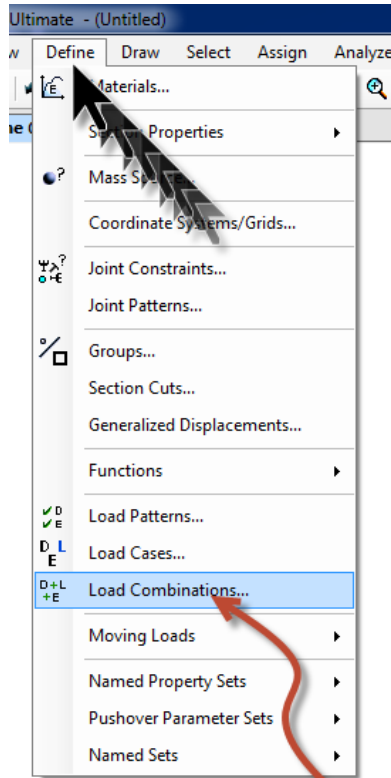

عمل حالات التحميل

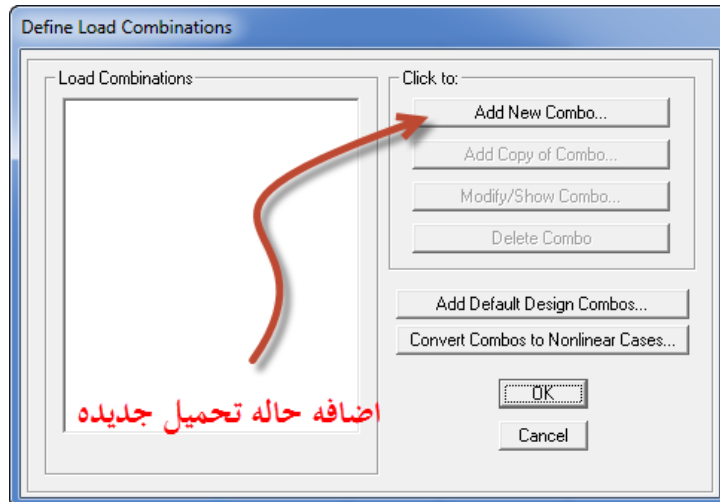

اضافه حاله تحميل جديده

Load Combination Data

Load Combination Name (User-Generated)

Notes

Load Combination Type

Options

Define Combination of Load Case Results

Load Case Name	Load Case Type	Scale Factor
WALL	Linear Static	1.4
DEAD	Linear Static	1.4
LL	Linear Static	1.6
WALL	Linear Static	1.4

الاحمال المضافه للحاله

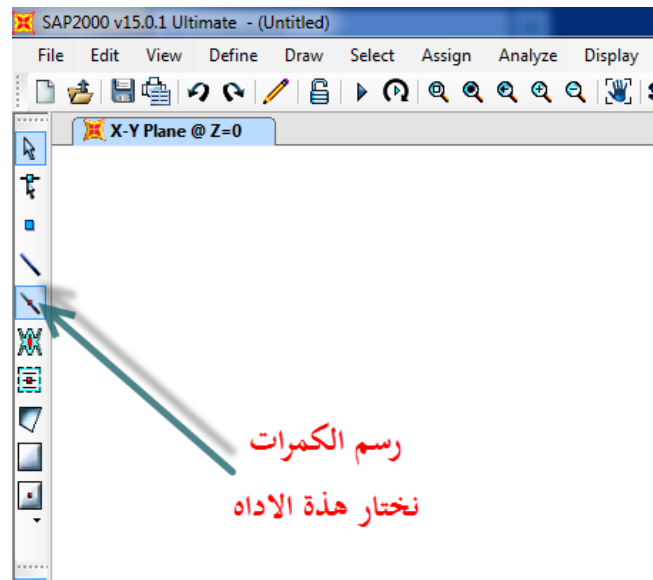

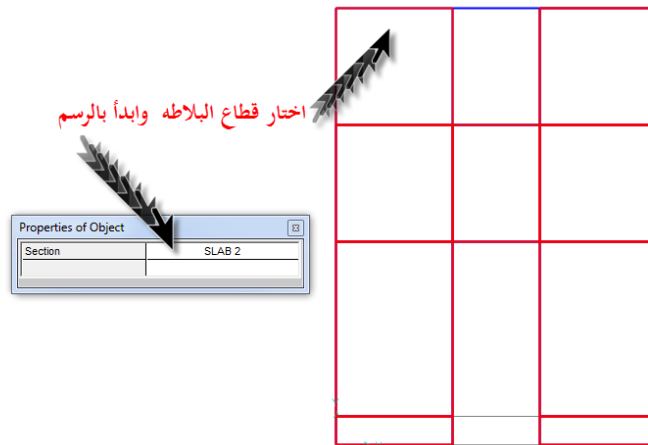
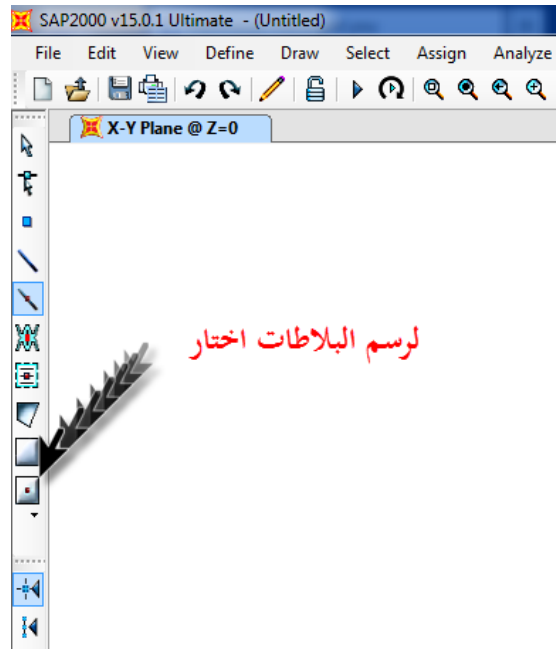
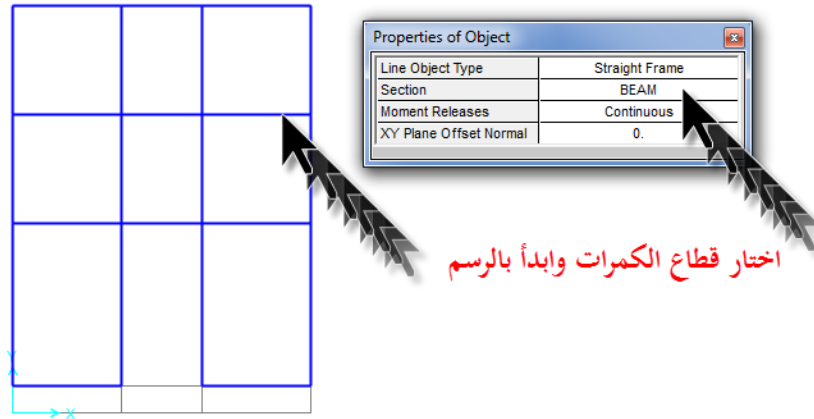



لاظهار البلاطات اختار

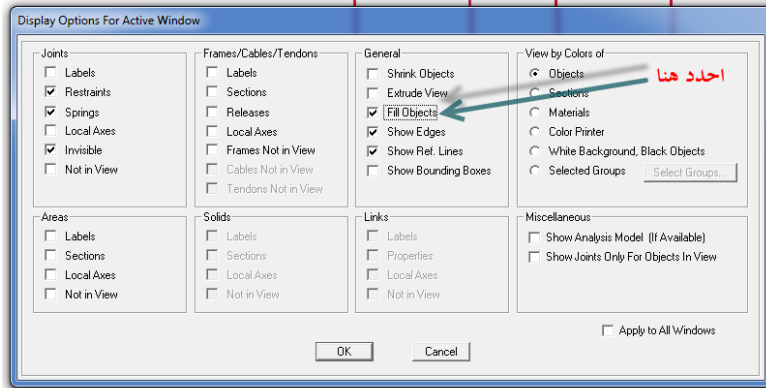

اجدد هنا

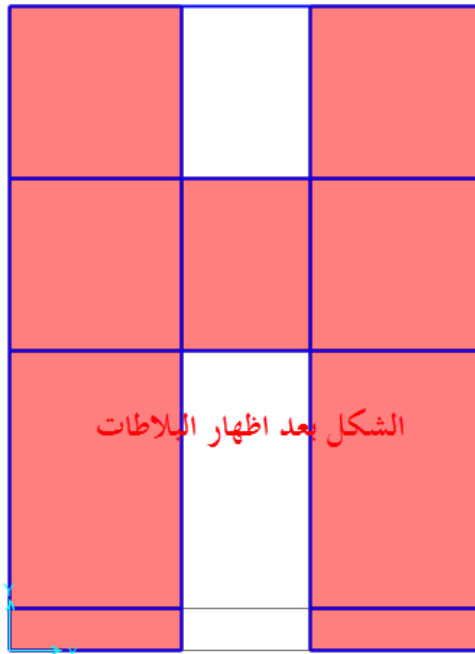

الشكل بعد اظهار البلاطات

لرسم السلم فتح فايل ساب جديد وادخال شبكة مسافات جديده خاصه بالسلم

Define Grid System Data

Edit Format

System Name: GLOBAL Units: Tonf, m, C

Grid Lines: Quick Start...

X Grid Data

Grid ID	Spacing	Line Type	Visibility	Bubble Loc.	Grid Color
1	1.2				
2	0.6				
3	1.2				
4	0				
5					
6					
7					
8					

عرض قالبة السلم
عرض الفانوس

Y Grid Data

Grid ID	Spacing	Line Type	Visibility	Bubble Loc.	Grid Color
1	1.65				
2	2.7				
3	1.65				
4	0				
5					
6					
7					
8					

طول السلم
صدقة السلم

Z Grid Data

Grid ID	Spacing	Line Type	Visibility	Bubble Loc.	Grid Color
1	0				
2					
3					
4					
5					
6					
7					
8					

Display Grids as:
 Ordinates Spacing

Hide All Grid Lines
 Glue to Grid Lines

Bubble Size: 2.4384

Reset to Default Color
Reorder Ordinates

OK Cancel

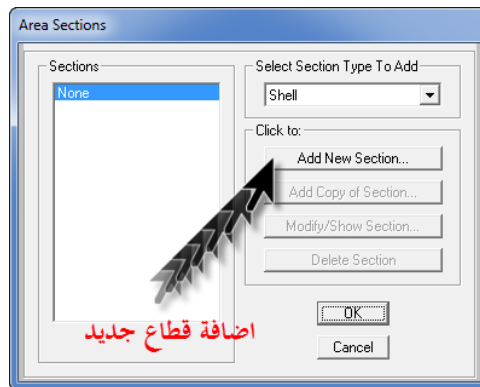
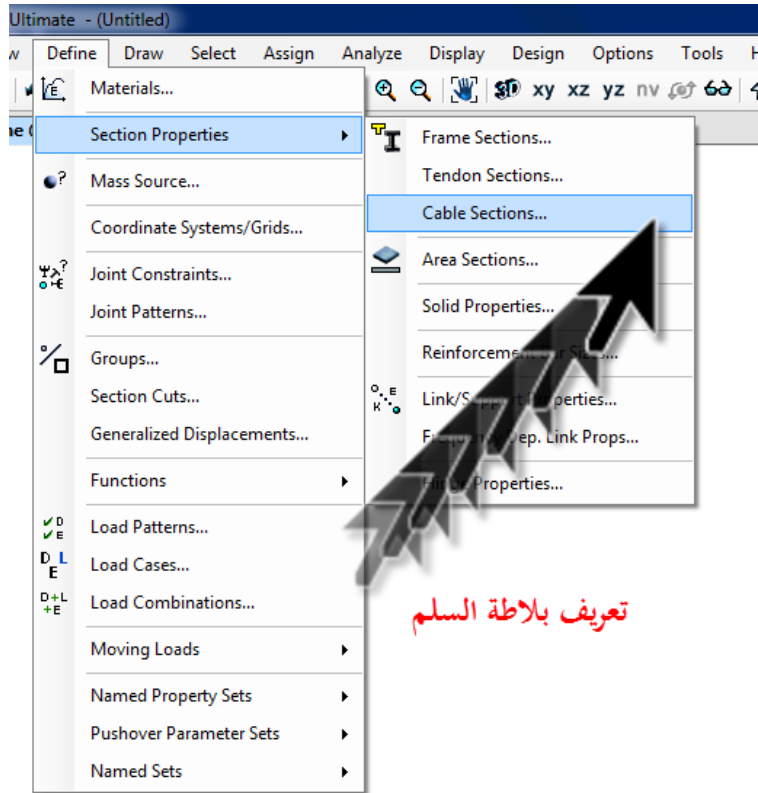

Shell Section Data

اسم قطاع البلاطة

Section Name: STR SLAB

Section Notes: Modify/Show...

Display Color:

Type:

- Shell - Thin
- Shell - Thick
- Plate - Thin
- Plate Thick
- Membrane
- Shell - Layered/Nonlinear

Modify/Show Layer Definition...

Material:

Material Name: + 4000Psi الماتريل

Material Angle: 0.

Thickness:

Membrane سمك البلاطة: .15

Bending: .15

Concrete Shell Section Design Parameters:

Modify/Show Shell Design Parameters...

Stiffness Modifiers: Set Modifiers...

Temp Dependent Properties: Thermal Properties...

OK Cancel



رسم بلاطة السلم

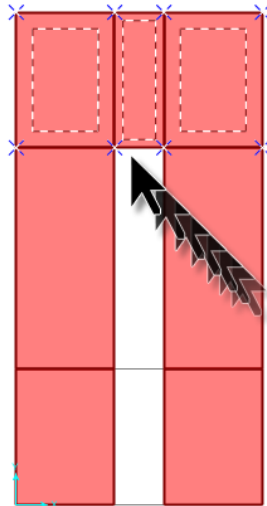

احدد على الاجزاء الموضحة لتغيير

منسوبها

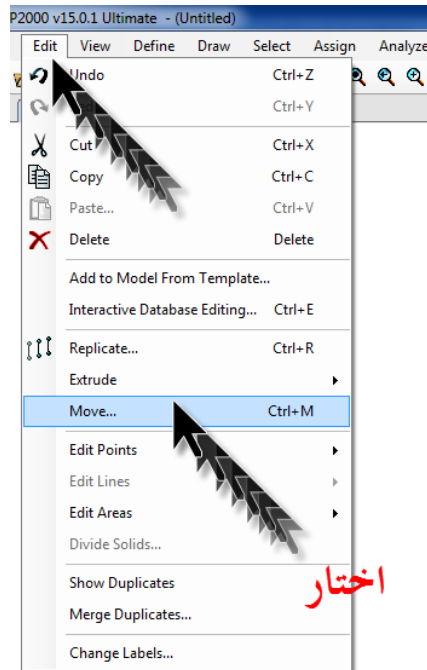

اختار

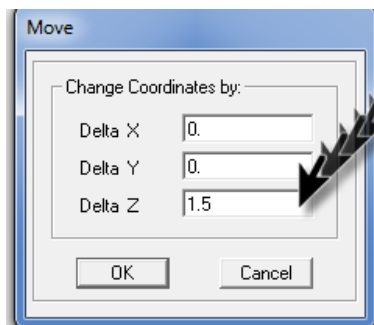

اعمل ازاحه بمقدار نص الدور في

اتجاه محور

Z



الشكل بعد عمل الازاحة
للمنسوب المطلوب

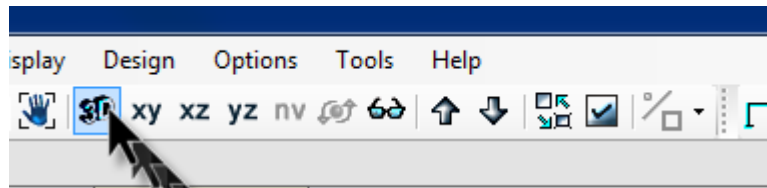

Set Default 3D View

للمشاهدة في 3 دي

الشكل في 3 دي

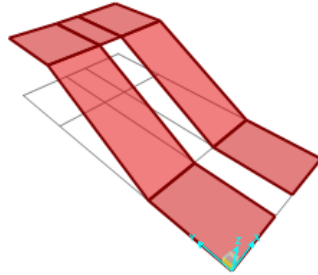

احدد هنا

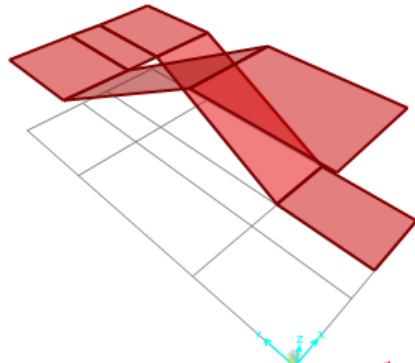
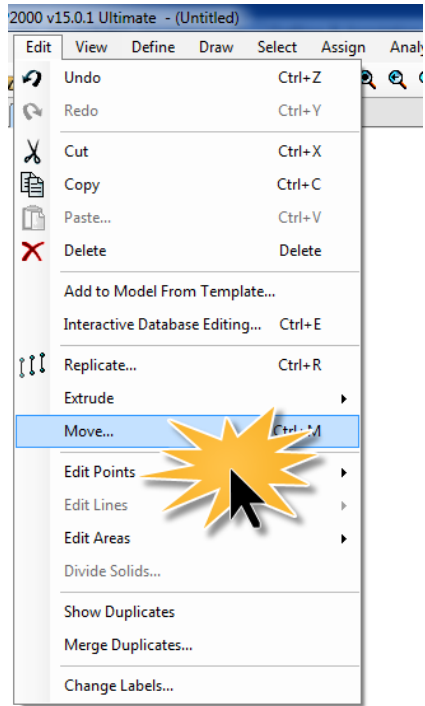

الشكل النهائي للسلم

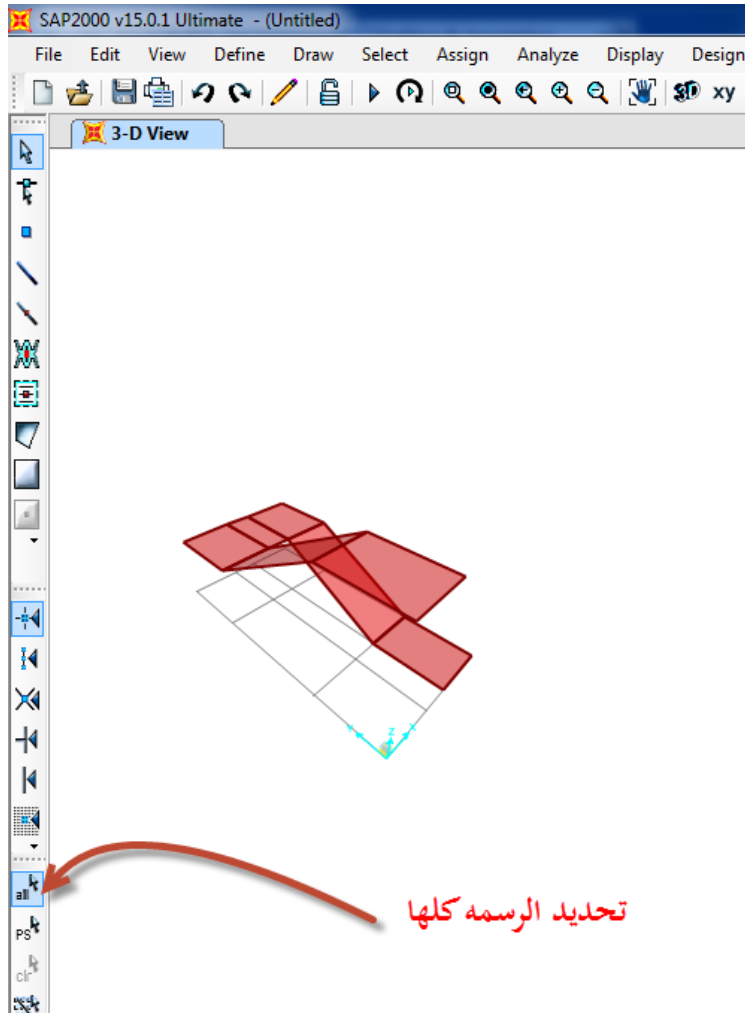

الشكل بعد التحديد عليه

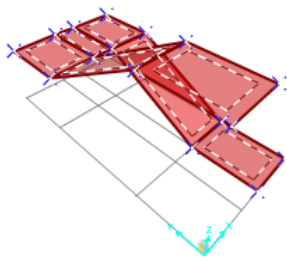

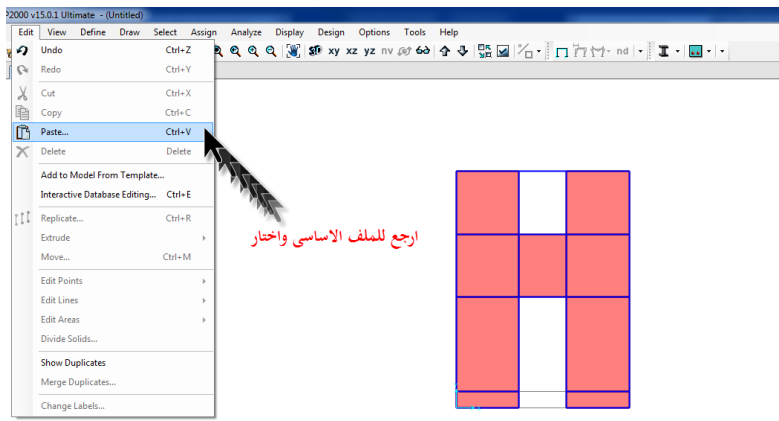
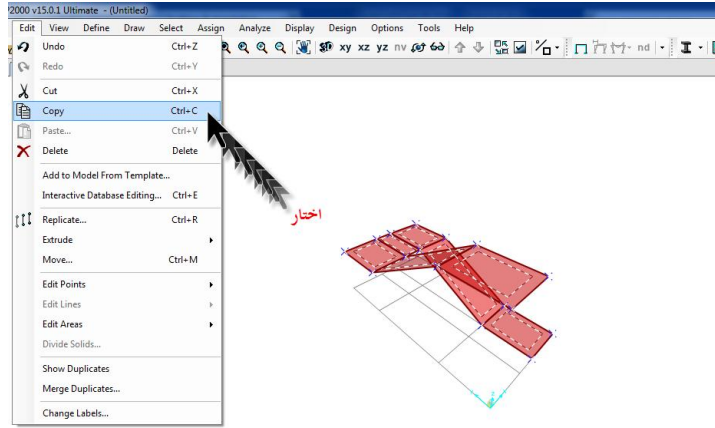

ادخل المسافات

لوضع السلم فى

مكانه على الرسم

Paste Coordinates

Change Coordinates by:

Delta X	4
Delta Y	1
Delta Z	-1.5

OK Cancel

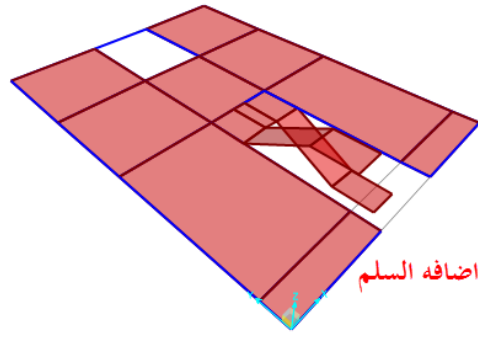

الشكل بعد اضافه السلم

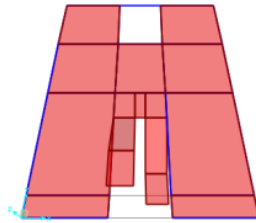

Properties of Object	
Line Object Type	Straight Frame
Section	BEAM
Moment Releases	Continuous
XY Plane Offset Normal	0
Drawing Control Type	None <space bar>

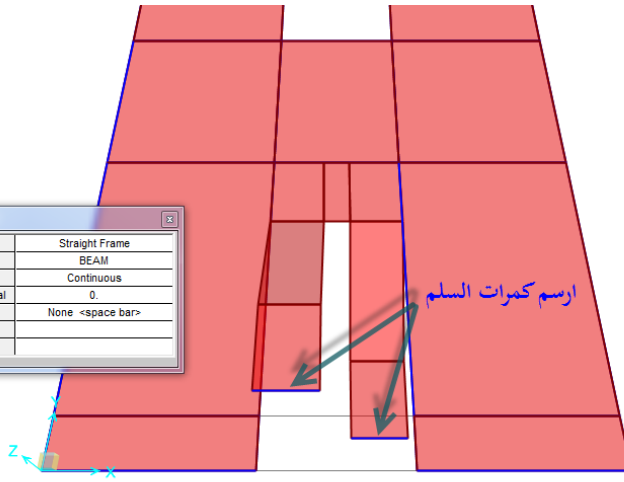

ارسم كمرات السلم

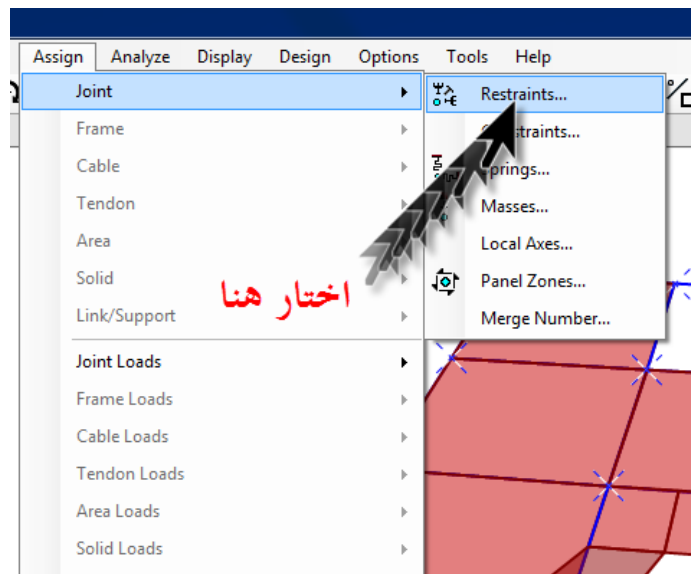
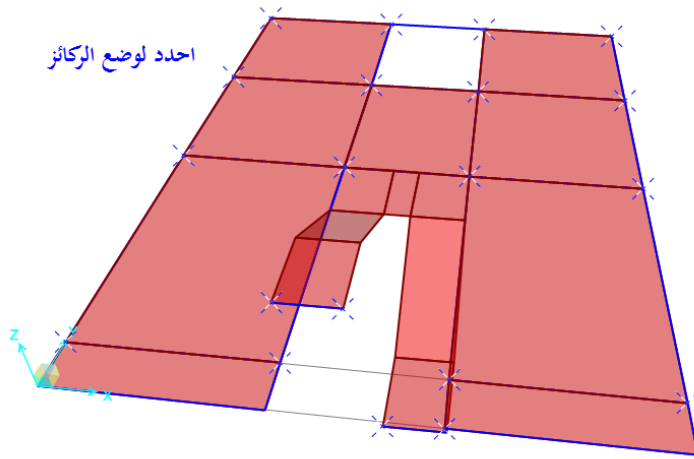

بعد اضافة الركائز

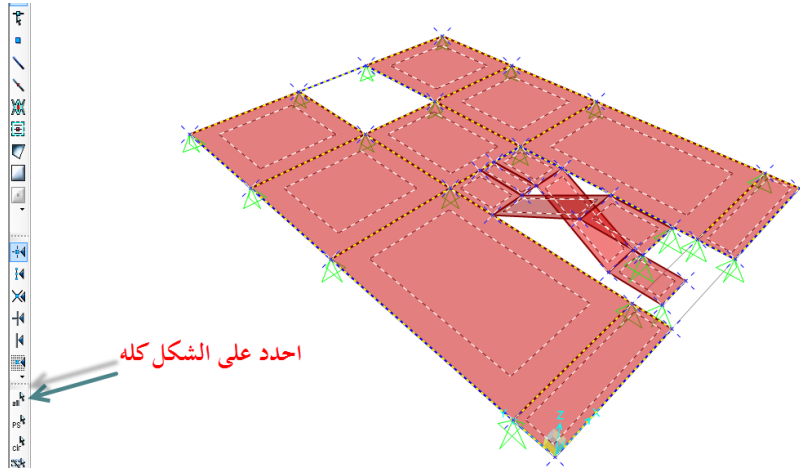
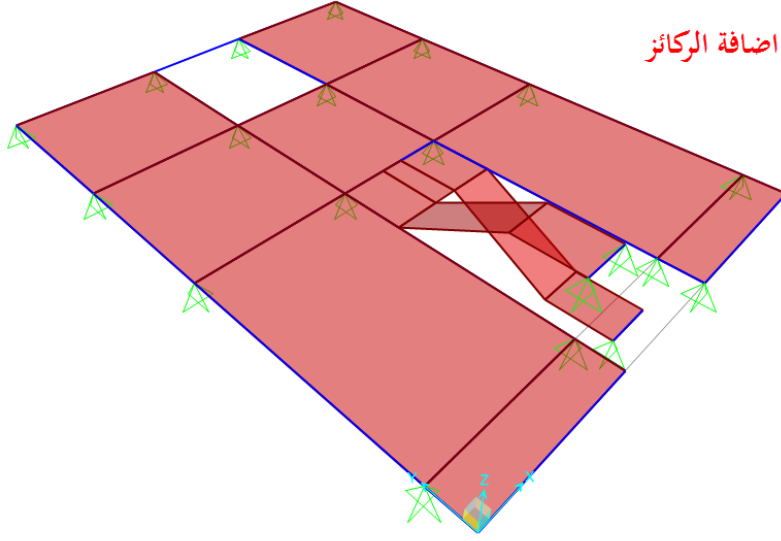

احدد على الشكل كله

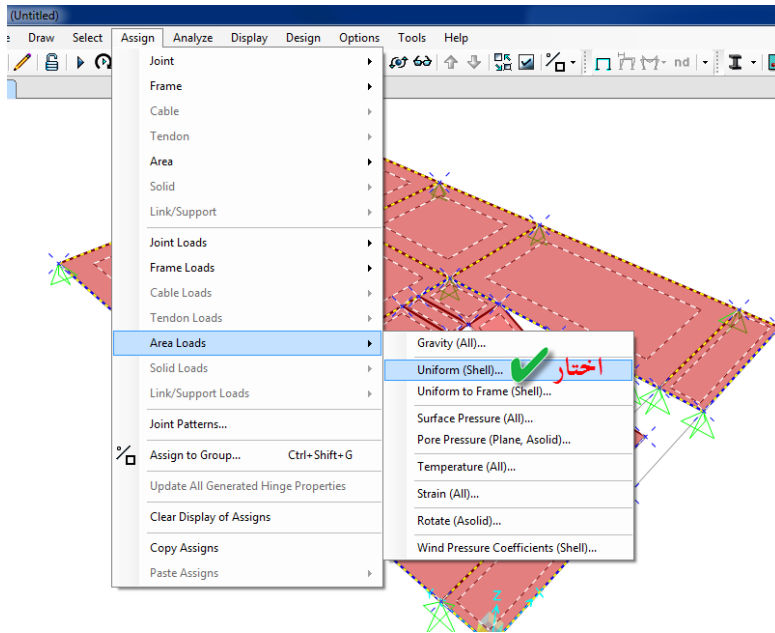

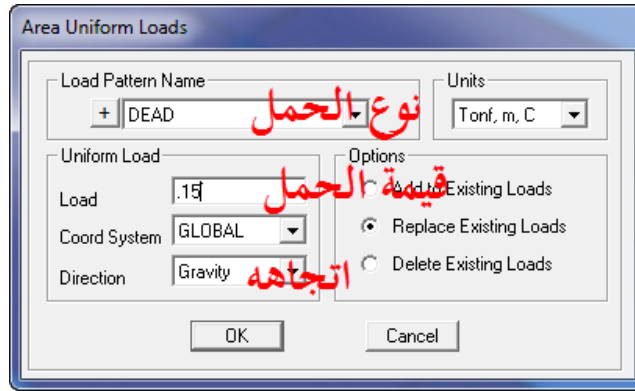

احدد الشكل مره اخرى واقوم باضافه
الاحمال الحيه بنفس الطريقه السابقه

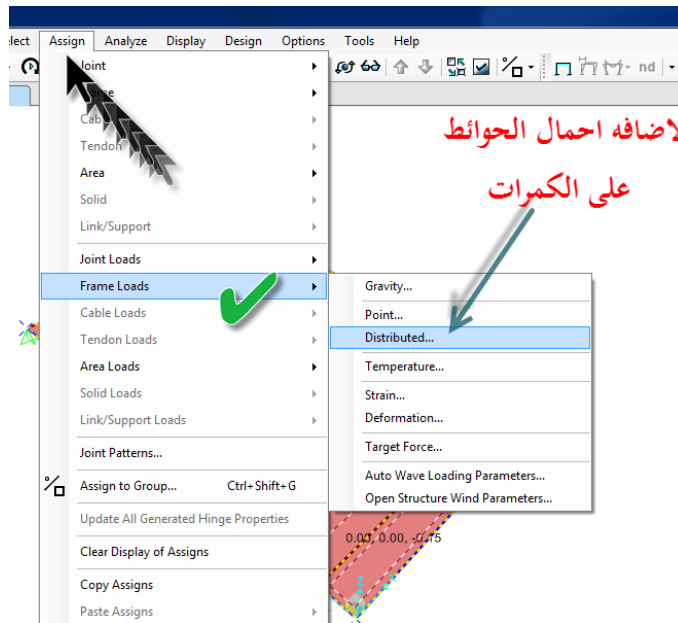
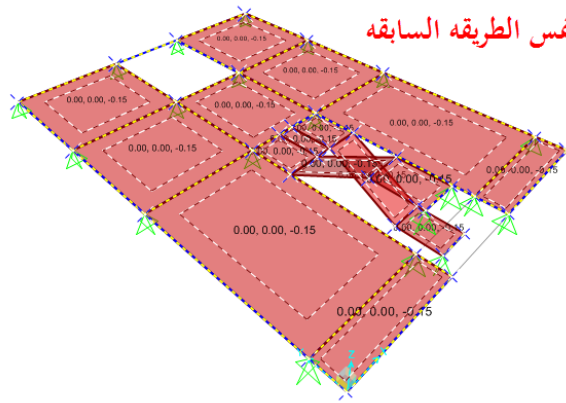

Frame Distributed Loads

Load Pattern Name: Units:

Load Type and Direction: Forces Moments
 Coord Sys:
 Direction:

Options: Add to Existing Loads
 Replace Existing Loads
 Delete Existing Loads

Trapezoidal Loads:

	1.	2.	3.	4.
Distance	<input type="text" value="0."/>	<input type="text" value="0.25"/>	<input type="text" value="0.75"/>	<input type="text" value="1."/>
Load	<input type="text" value="0."/>	<input type="text" value="0."/>	<input type="text" value="0."/>	<input type="text" value="0."/>

Relative Distance from End-I Absolute Distance from End-I

Uniform Load: Load **قيمة الحمل** OK Cancel

الشكل بعد اضافة الاحمال

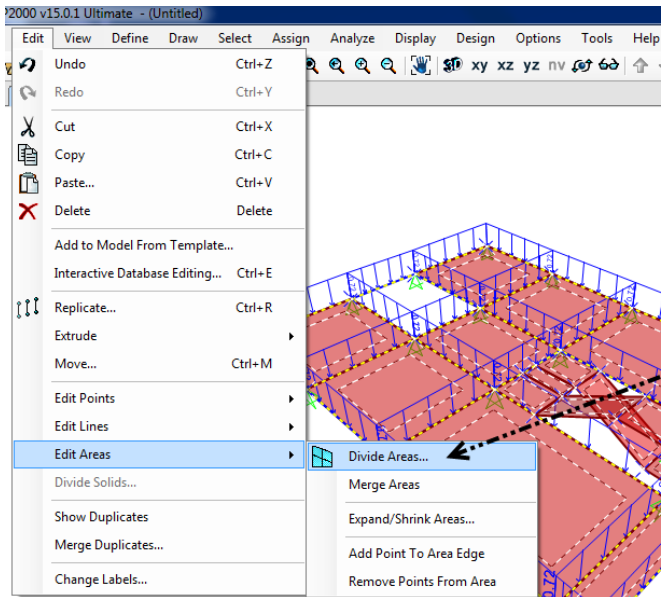
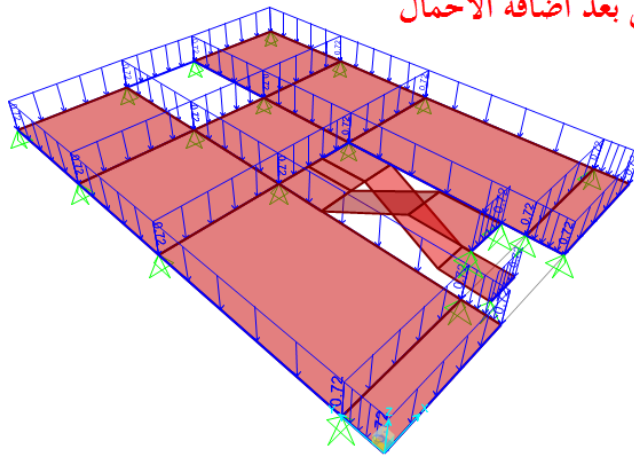

احدد على الشكل واقوم

بتقسيم البلاطات لاجزاء

صغير لضمان الدقه فى

التحليل

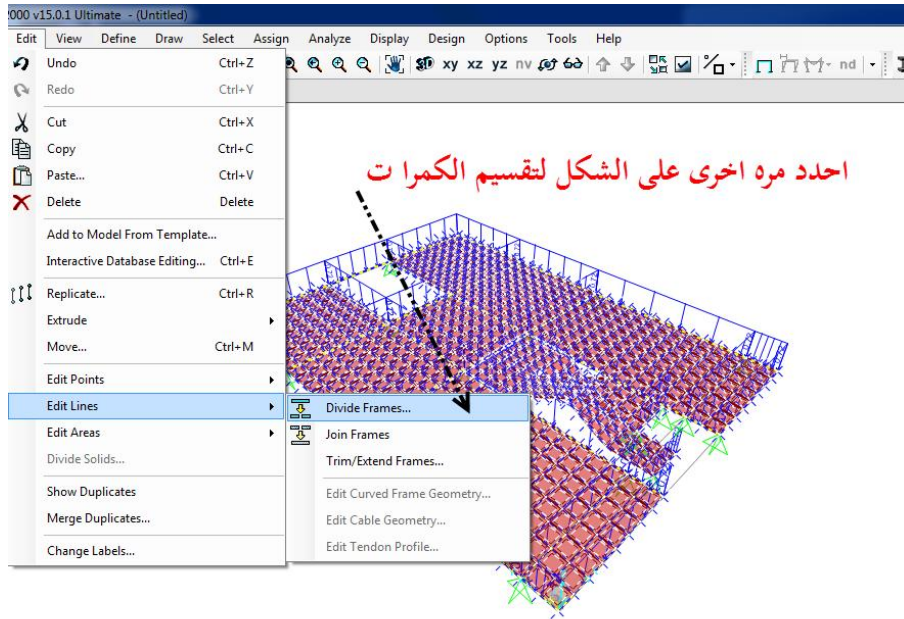
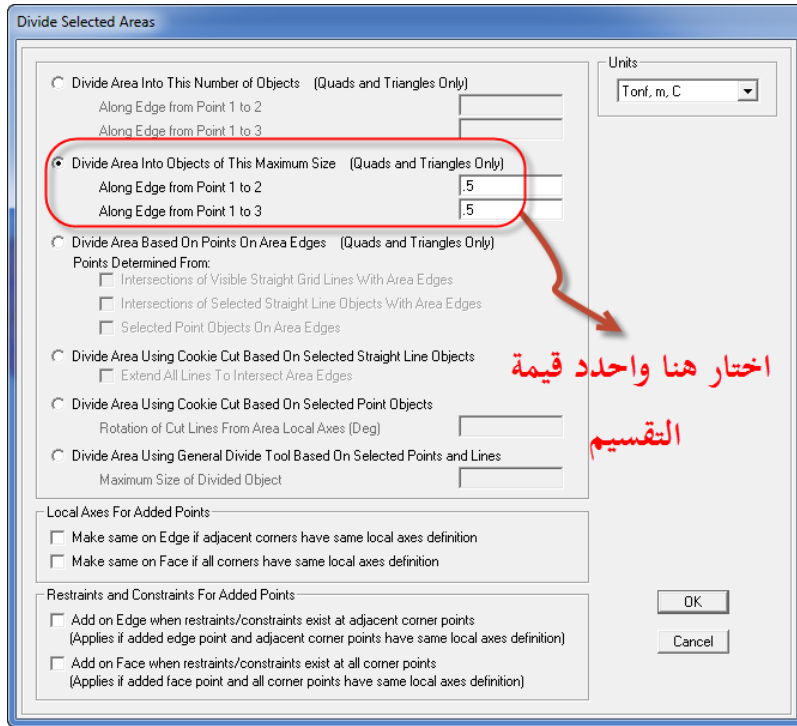

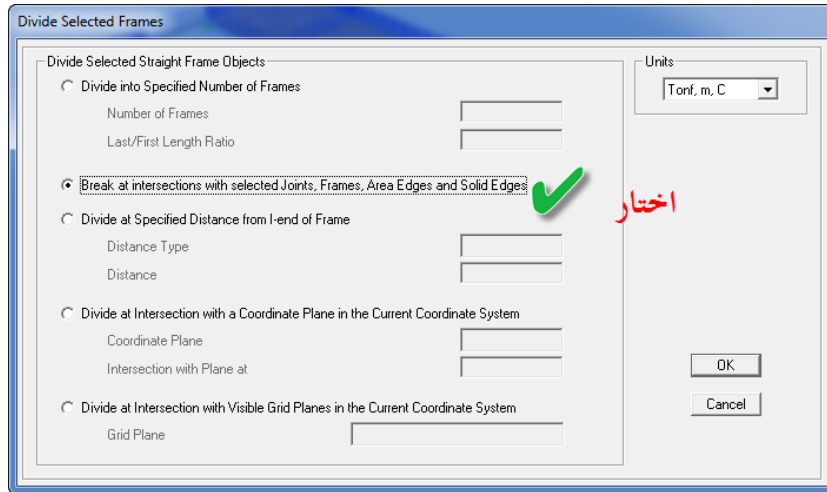

اختار هنا لبيان تقسيم الشكل

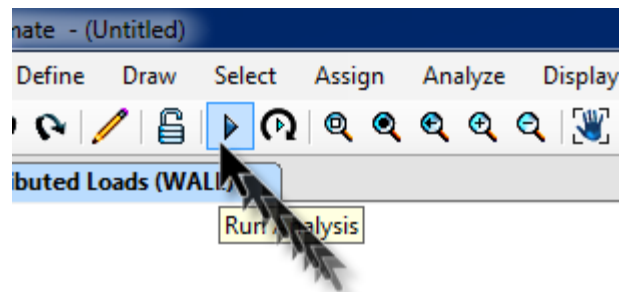
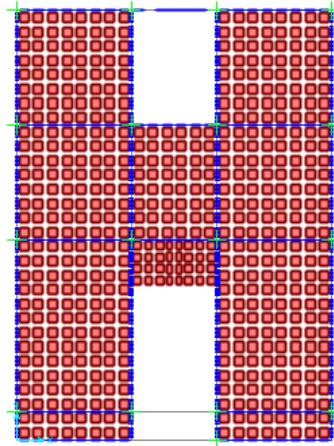

لبداء تحليل المنشأ اختار

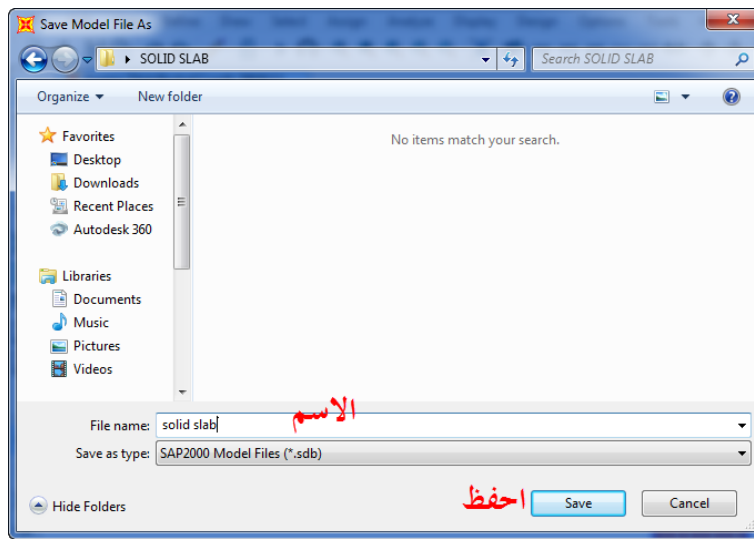
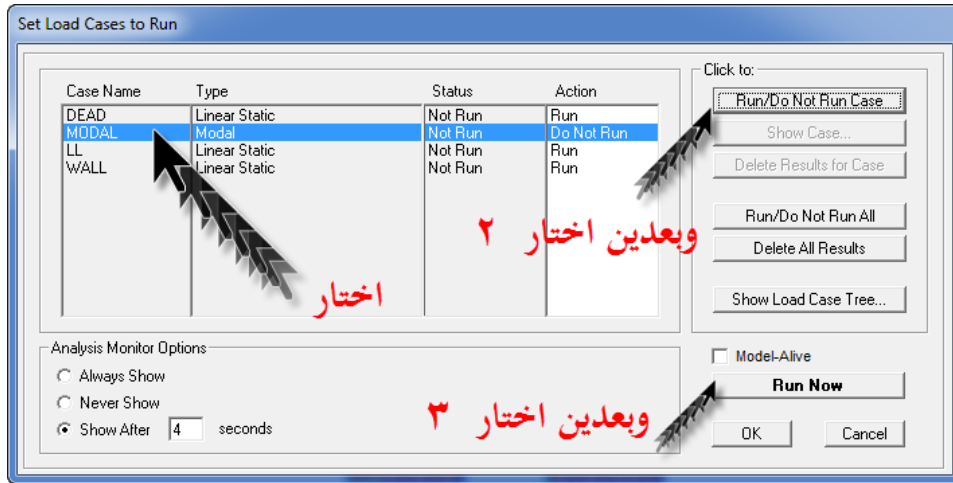

شكل المنشأ نتيجة الاحمال

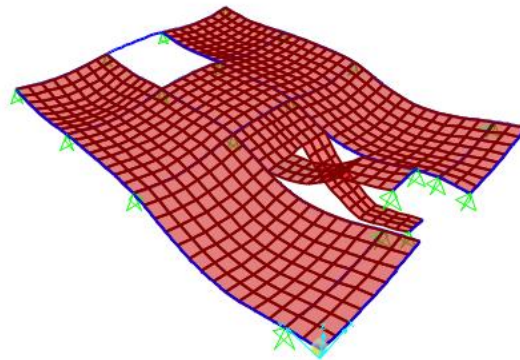

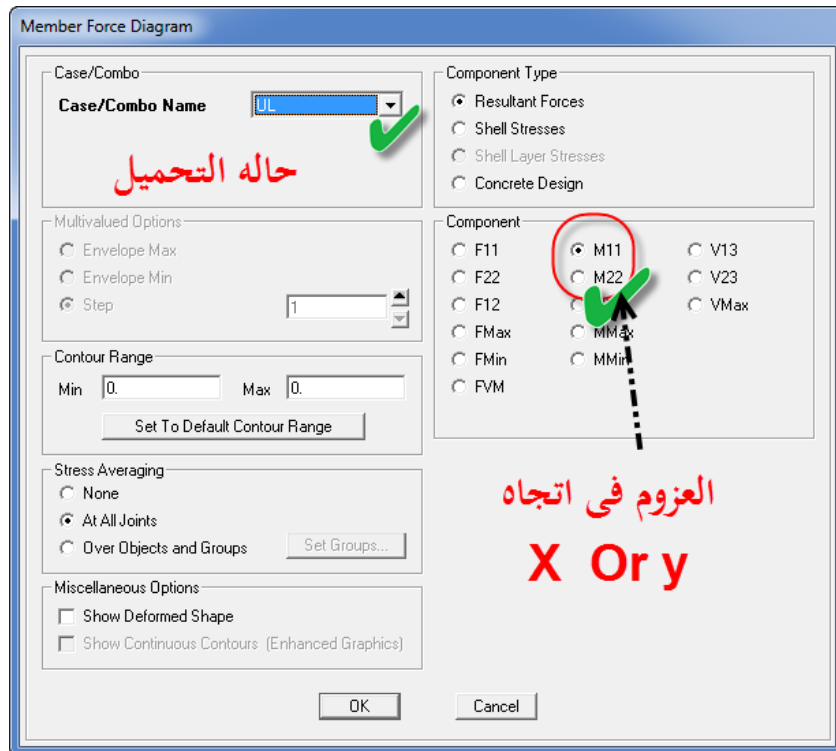
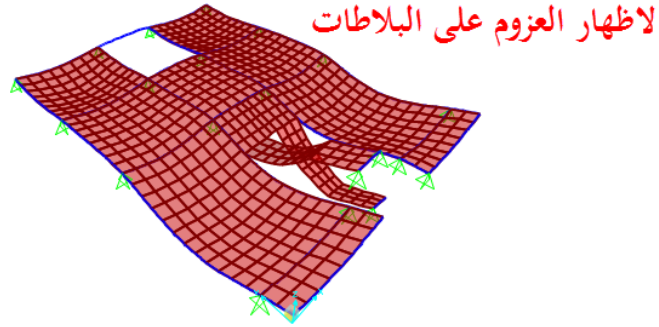
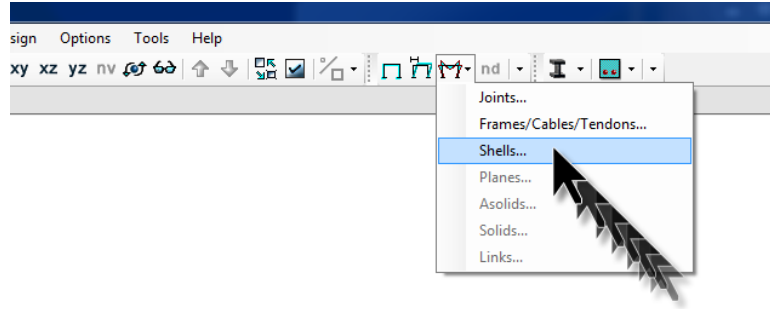

افرض قيمة حديد التسليح

5Ø10

وبالتعويض في القانون

$$A_s = M_u / F_y * J * d$$

بفرض ان ناتج العزم

$$m_u = 1.69$$

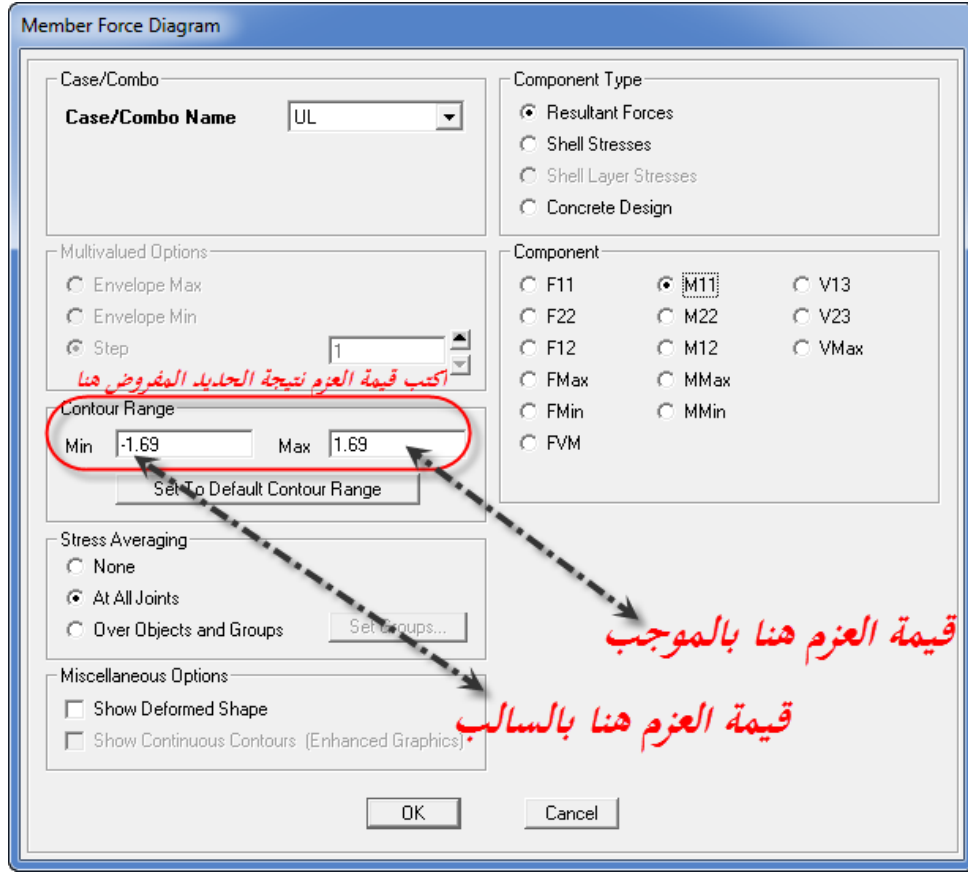

لو ظهر معايا اللون دا يبقى الحديد المفروض غير امن ويحتاج الى حديد اضافي او زياده في حديد التسليح

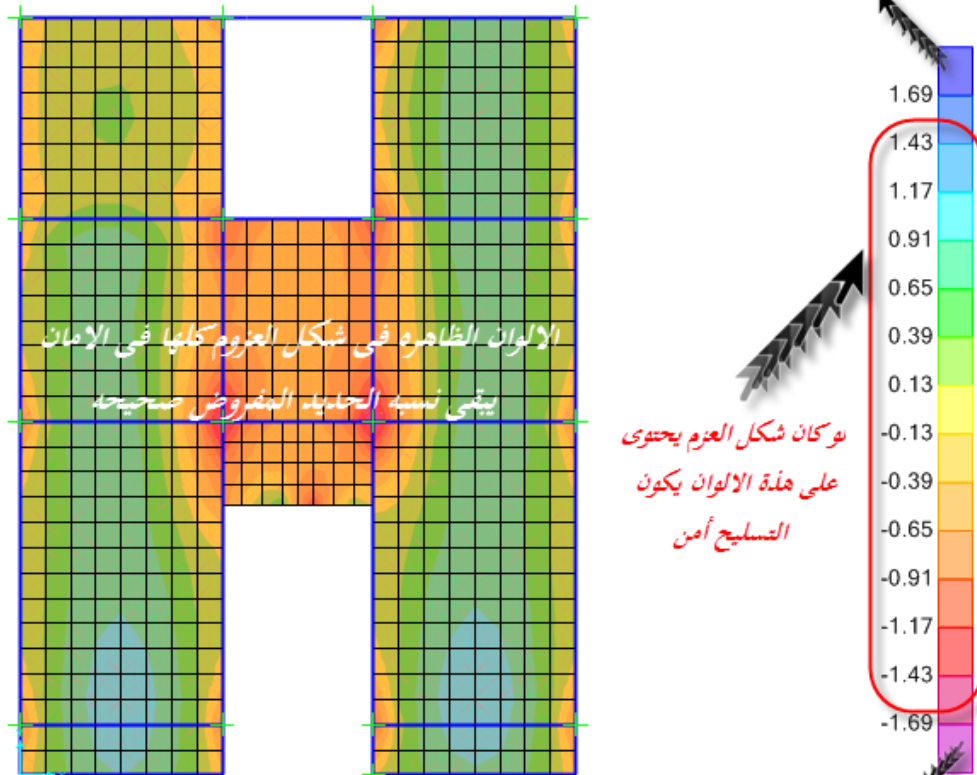

لو ظهر معايا اللون دا يبقى الحديد المفروض غير امن ويحتاج الى حديد اضافي او زياده في حديد التسليح

مسائل محلولة على برنامج الساب

إعداد

مهندس: خالد عبد الكريم

Eng.kh_ahmed@yahoo.com

01063366722 Or 01140506722

www.facebook.com/Eng.Khaled.Abdelkarim

Flat Slab

e]

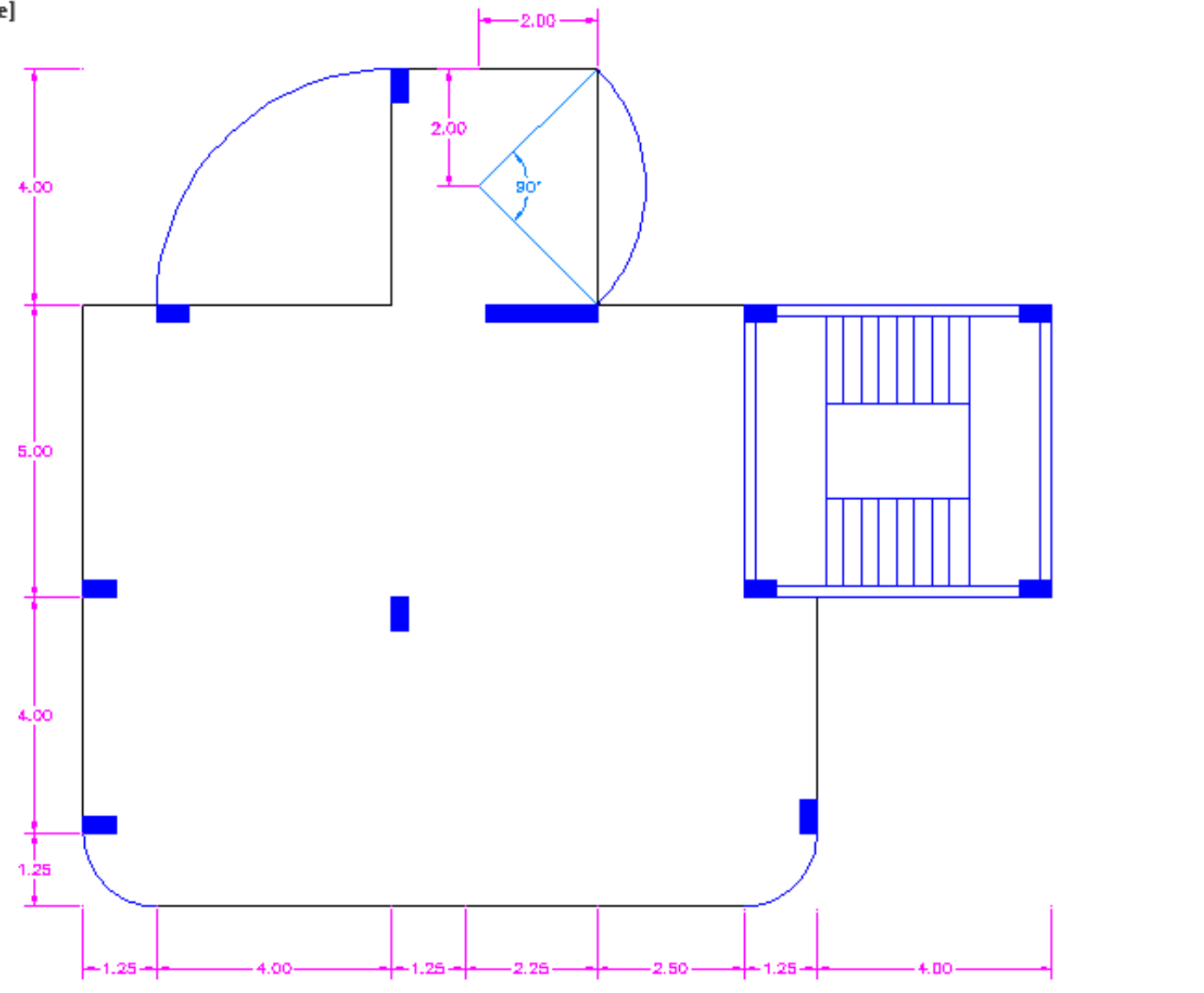

floor hight = 3m

wall thickness = 12 cm

beam 1 = 70*25 cm²

beam2 = 60* 12 cm²

Ts = 20 cm

LL = 0.4 t/m²

Floor cover =0.15 t/m²

Eq loads on slabs =0.2 t/m²

Solution

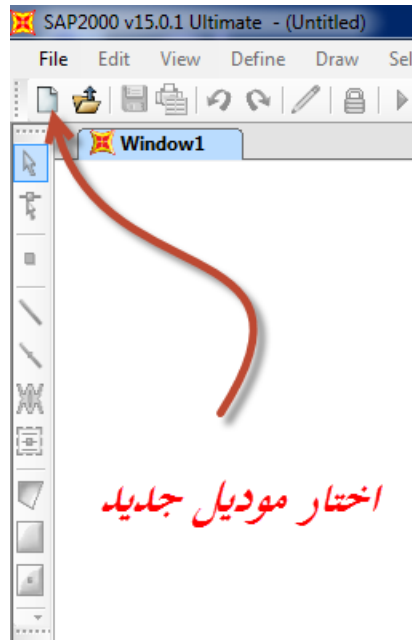
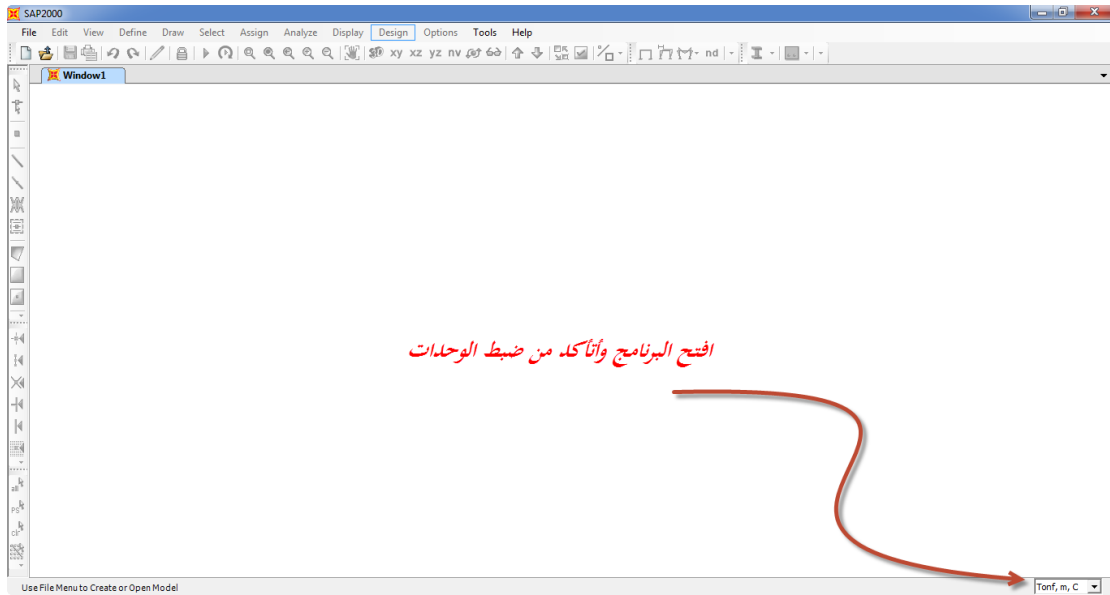

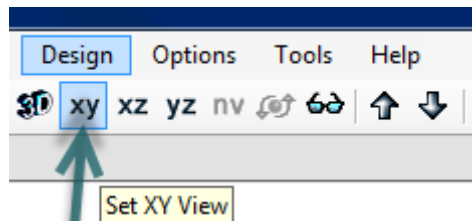
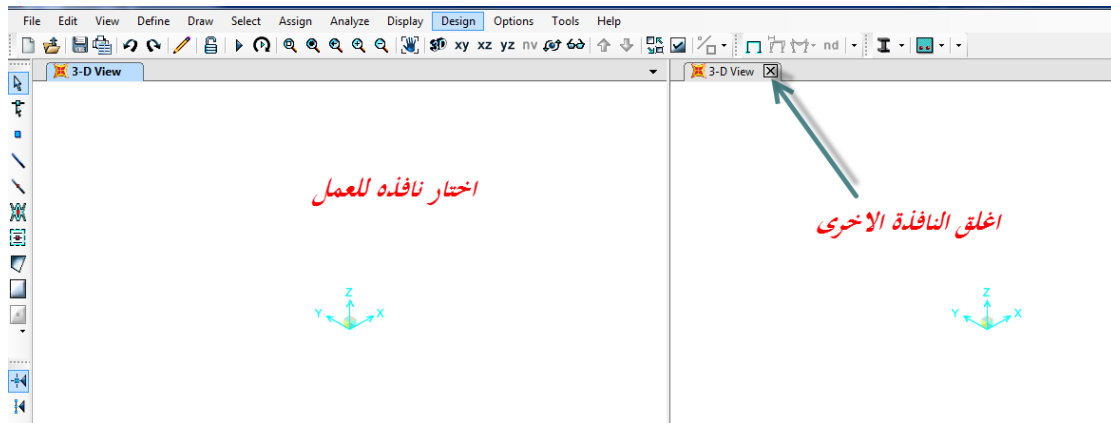
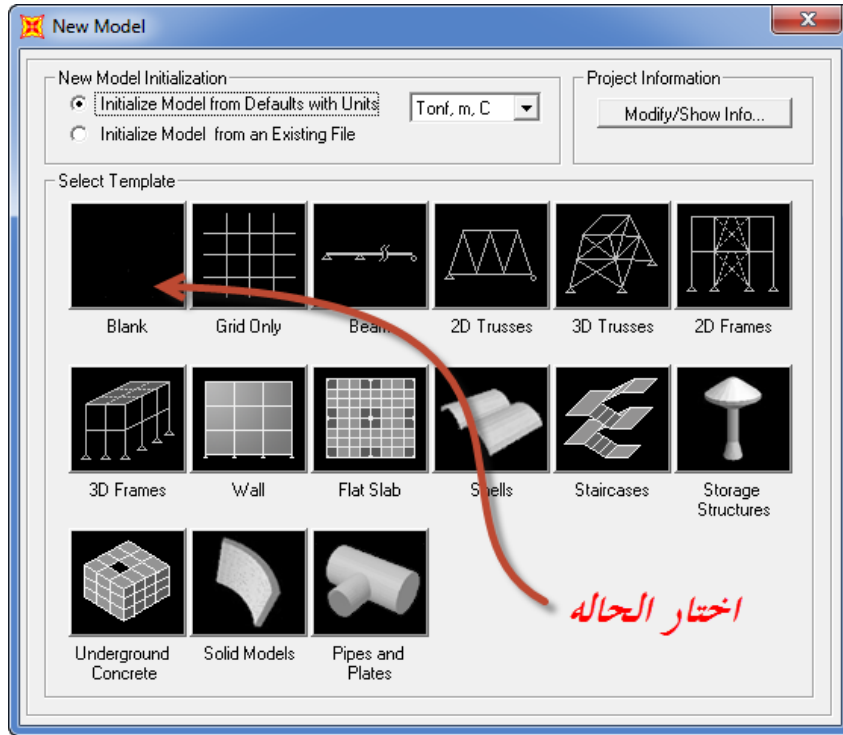

اختار مستوى العمل

كليك يمين في اى مكان على الشاشة واختار

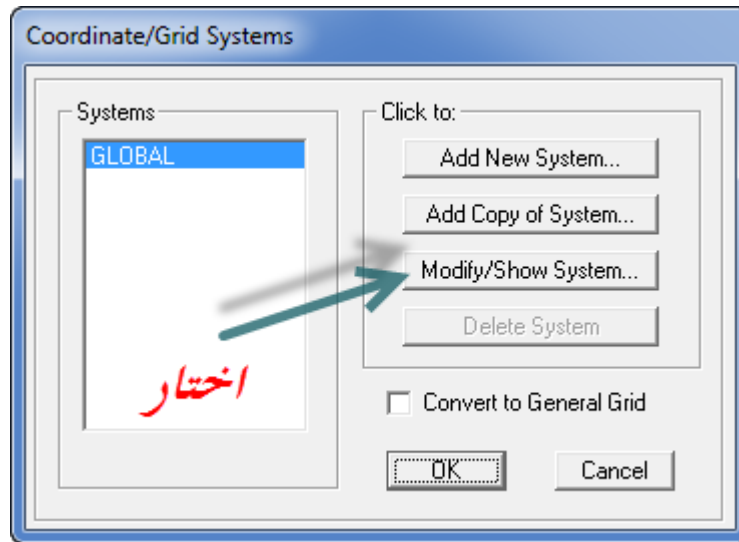
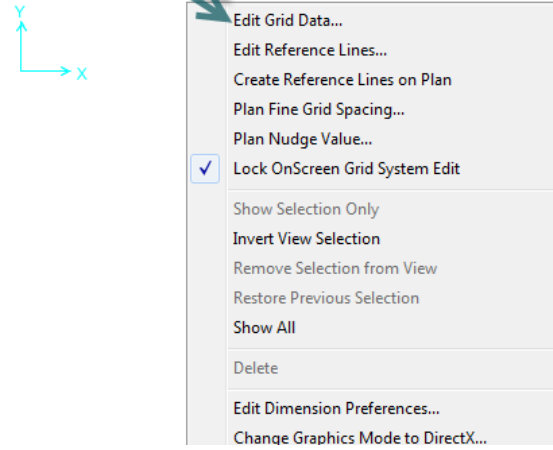

Define Grid System Data

Edit Format

System Name: GLOBAL Units: Tonf, m, C Grid Lines: Quick Start...

X Grid Data

	Grid ID	0	Line Type	Visibility	Bubble Loc.	Grid Color
1	A	1.25				
2	B	4				
3	C	1.25				
4	D	2.25				
5	E	2.5				
6	F	1.25				
7	G	4				
8	H	0				

Y Grid Data

	Grid ID	0	Line Type	Visibility	Bubble Loc.	Grid Color
1	1	1.25				
2	2	4				
3	3	5				
4	4	4				
5	5	0				
6						
7						
8						

Z Grid Data

	Grid ID	0	Line Type	Visibility	Bubble Loc.
1					
2					
3					
4					
5					
6					
7					
8					

Display Grids as:

Ordinate Spacing

طريقة الإدخال

Hide All Grid Lines

Glue to Grid Lines

Bubble Size: 1

Reset to Default Color

Reorder Ordinates

OK Cancel

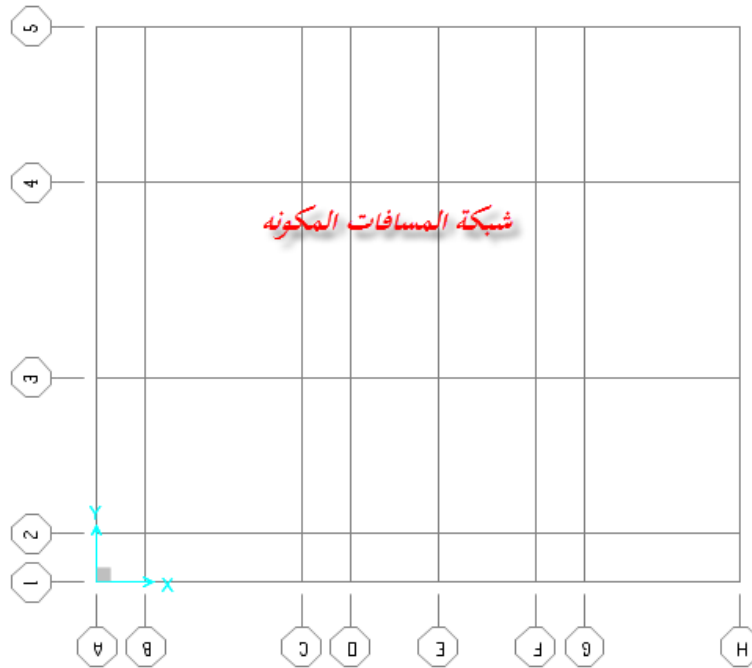

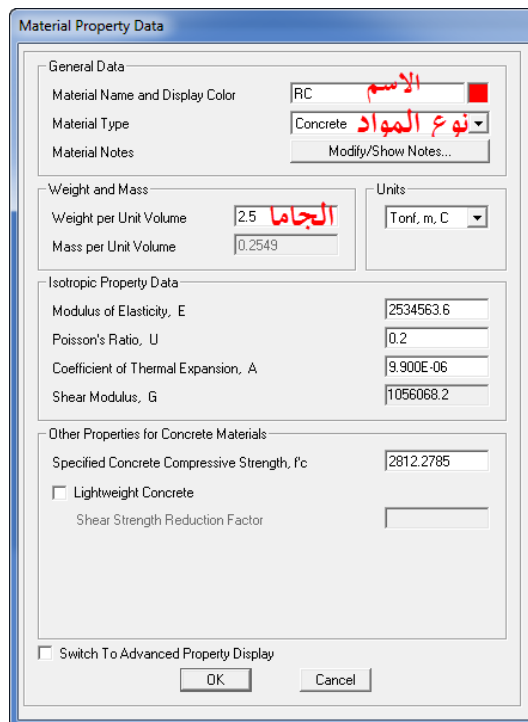
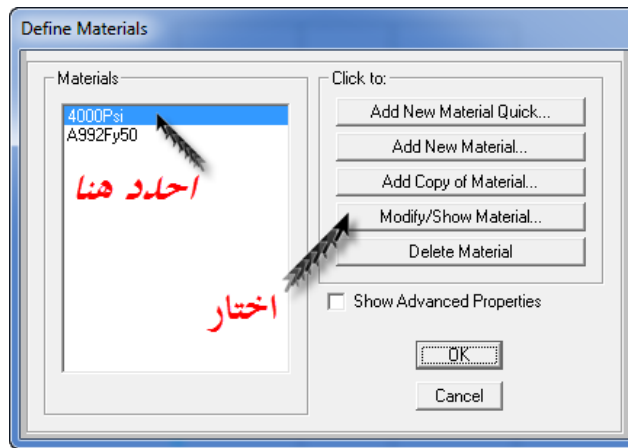
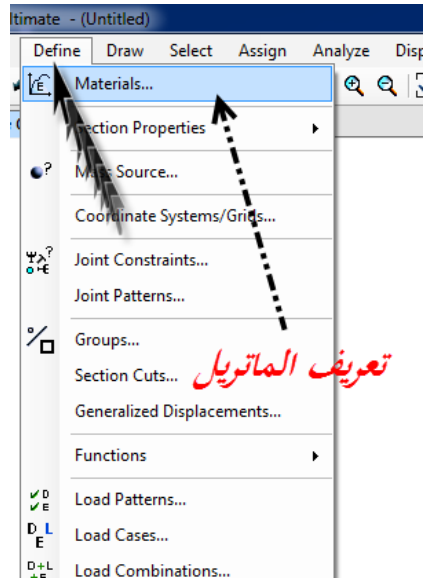

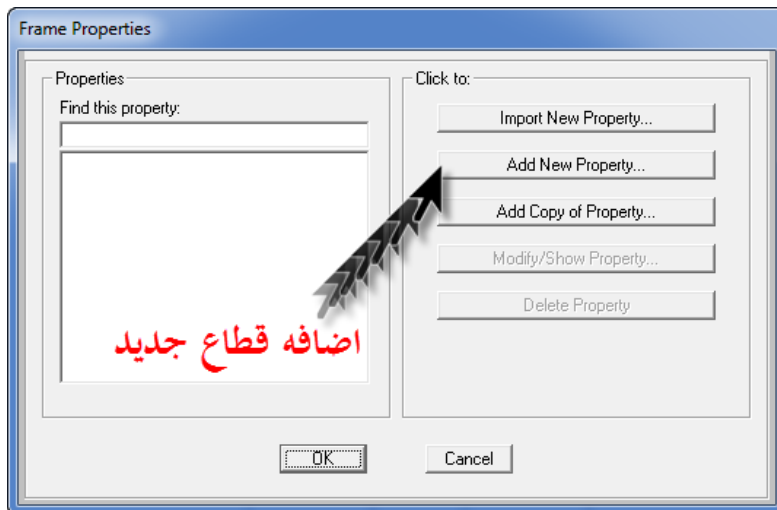
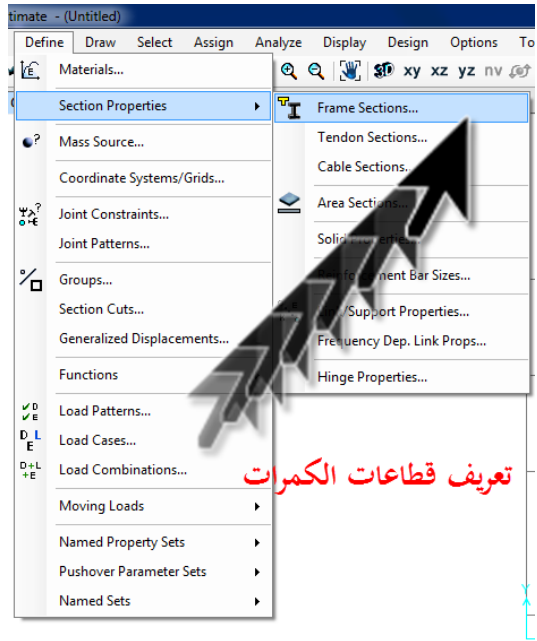

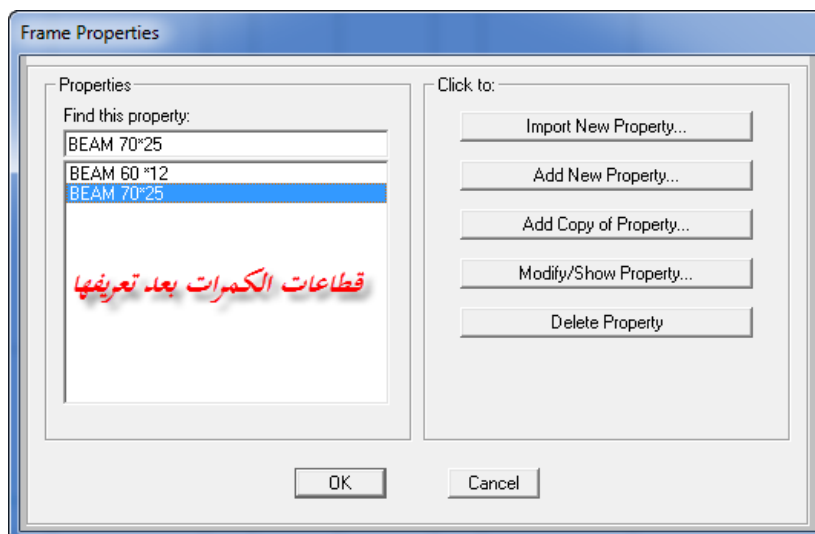
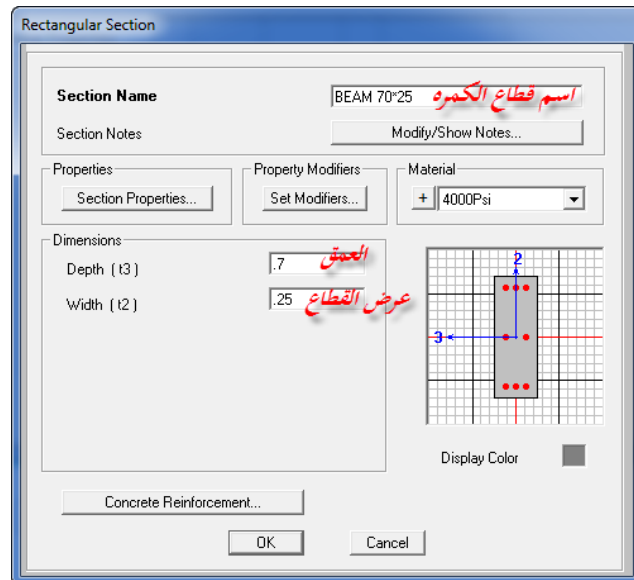
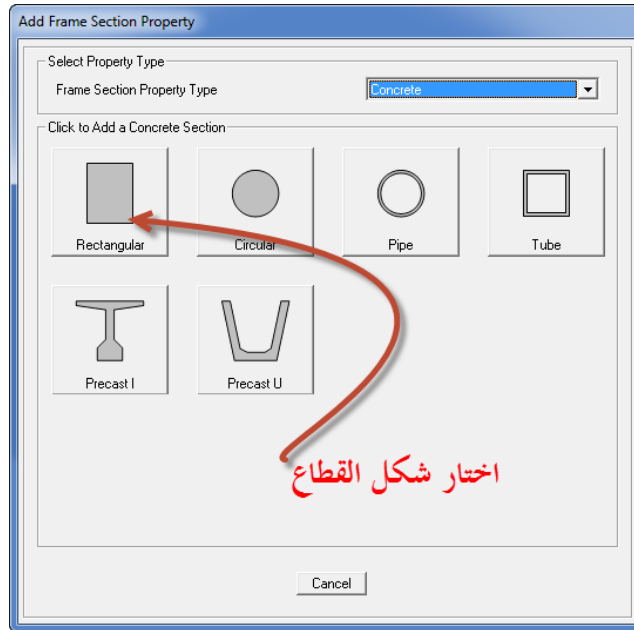

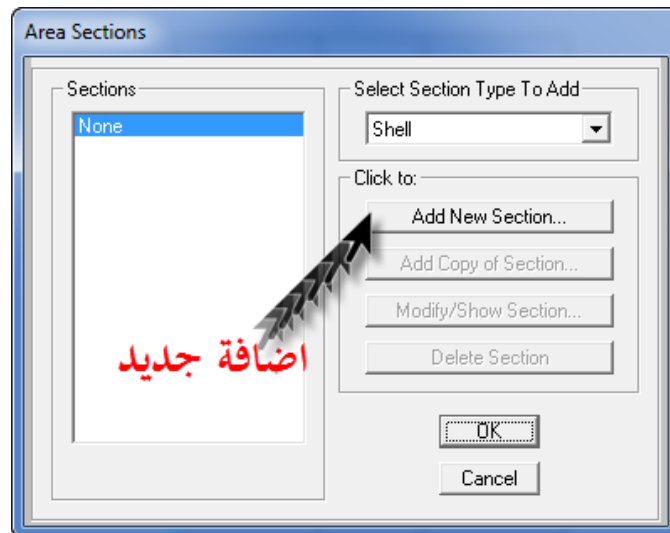
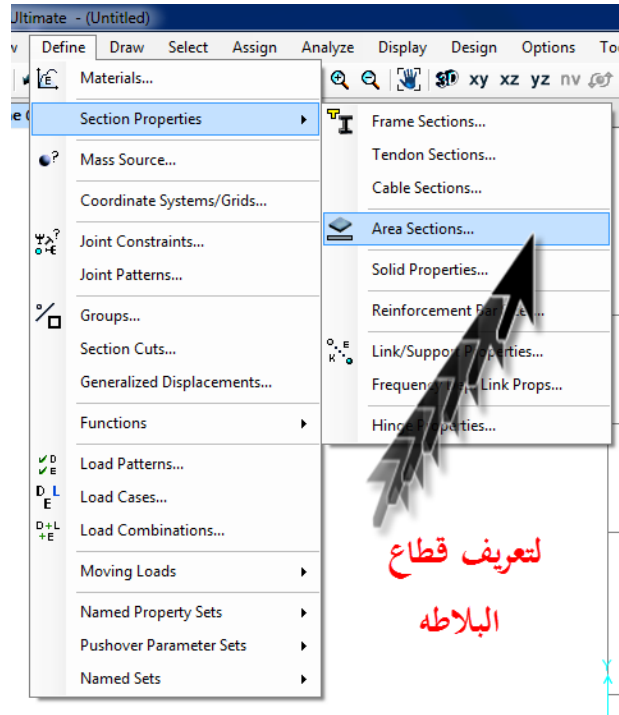

Shell Section Data

Section Name SLAB اسم البلاطة

Section Notes

Display Color

Type

- Shell - Thin
- Shell - Thick
- Plate - Thin
- Plate Thick
- Membrane
- Shell - Layered/Nonlinear

Material

Material Name + 4000Psi

Material Angle 0.

Thickness

Membrane اكتب سمك 0.20 ✓

Bending القطع 0.20 ✓

Concrete Shell Section Design Parameters

Stiffness Modifiers

Temp Dependent Properties

Area Sections

Sections

- None
- SLAB

البلاطة المضافه

Select Section Type To Add

Shell

Click to:

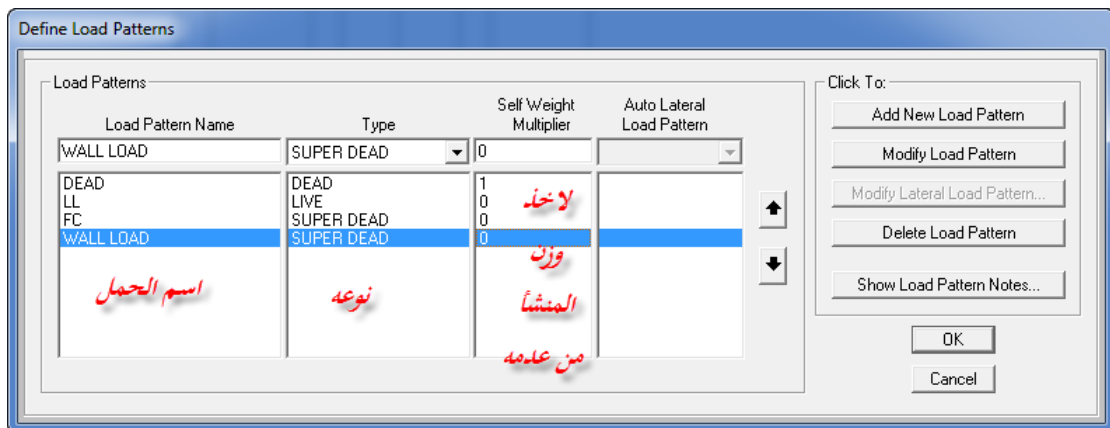
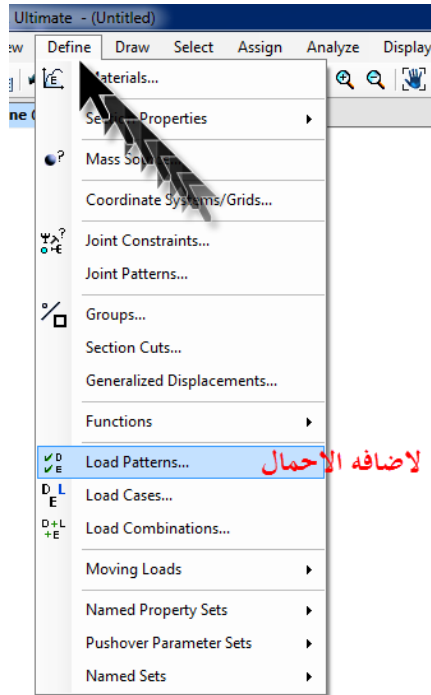

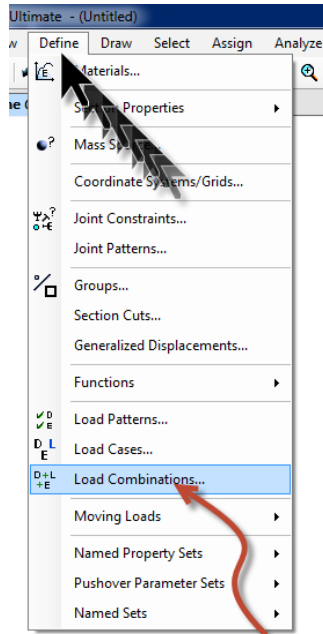

عمل حالات التحميل

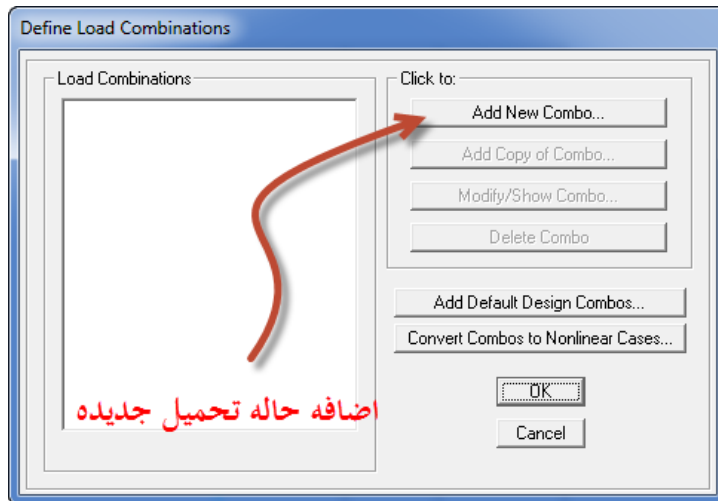

اضافه حالة تحميل جديد

Load Combination Data

Load Combination Name (User-Generated)

Notes

Load Combination Type

Options

Define Combination of Load Case Results

Load Case Name	Load Case Type	Scale Factor
LL	Linear Static	1.6
DEAD	Linear Static	1.4
FC	Linear Static	1.4
WALL LOAD	Linear Static	1.4
LL	Linear Static	1.6

الإحمال المضافة للحاله

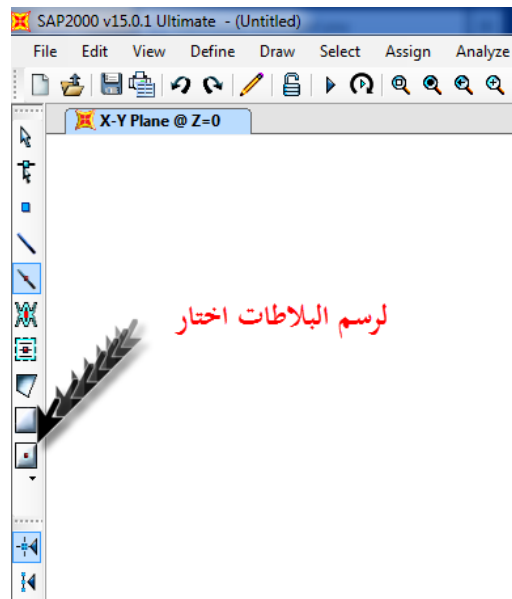
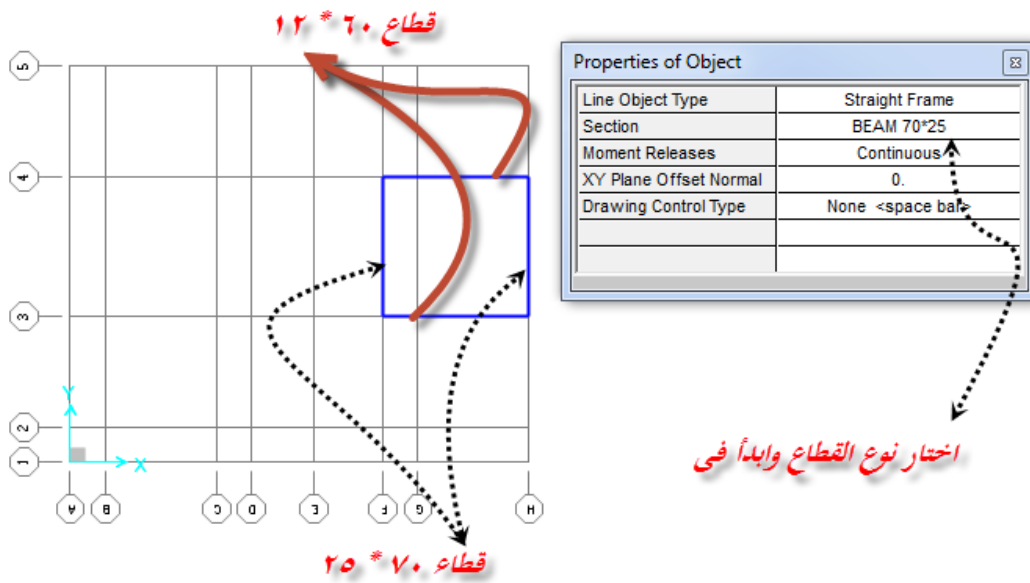
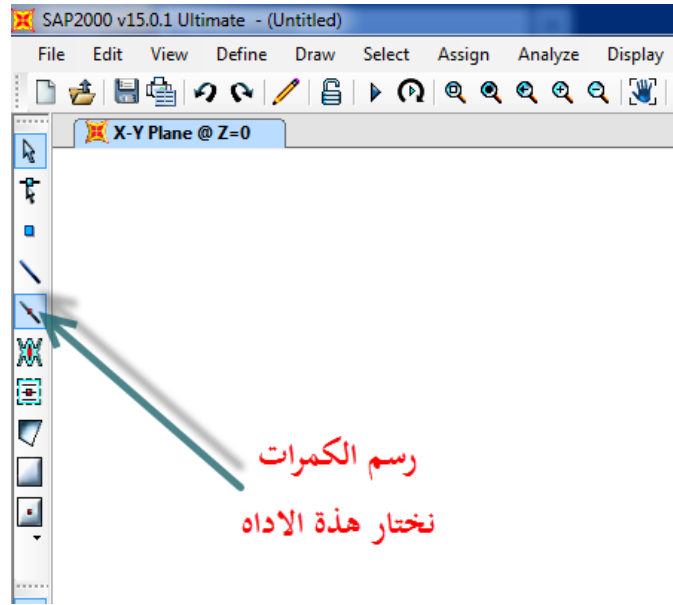

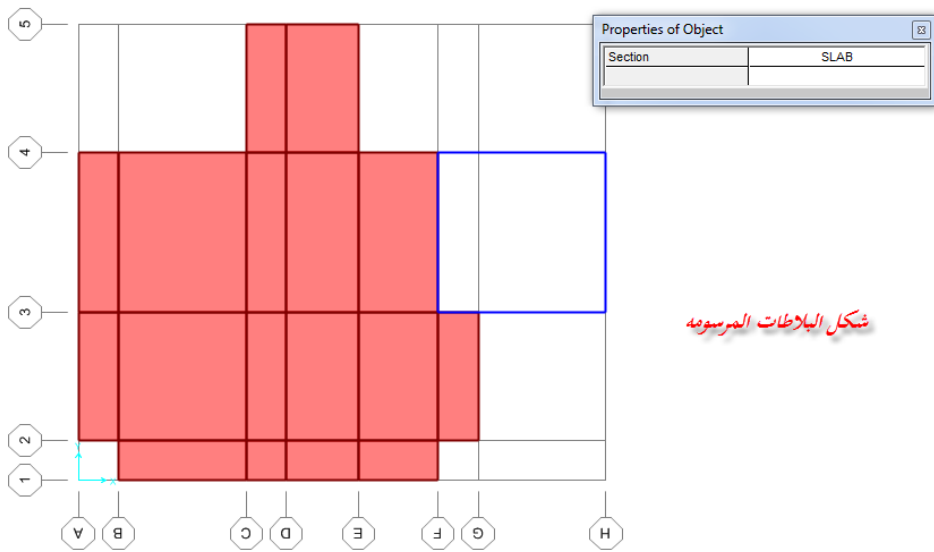
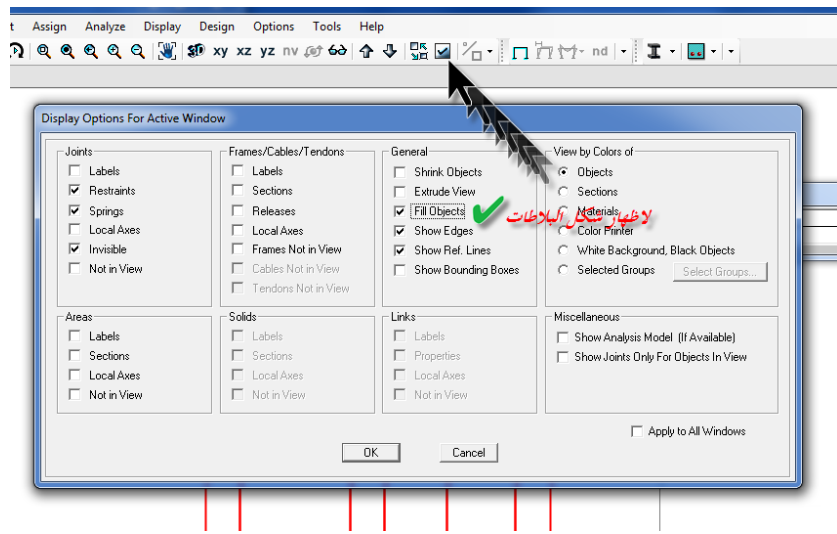

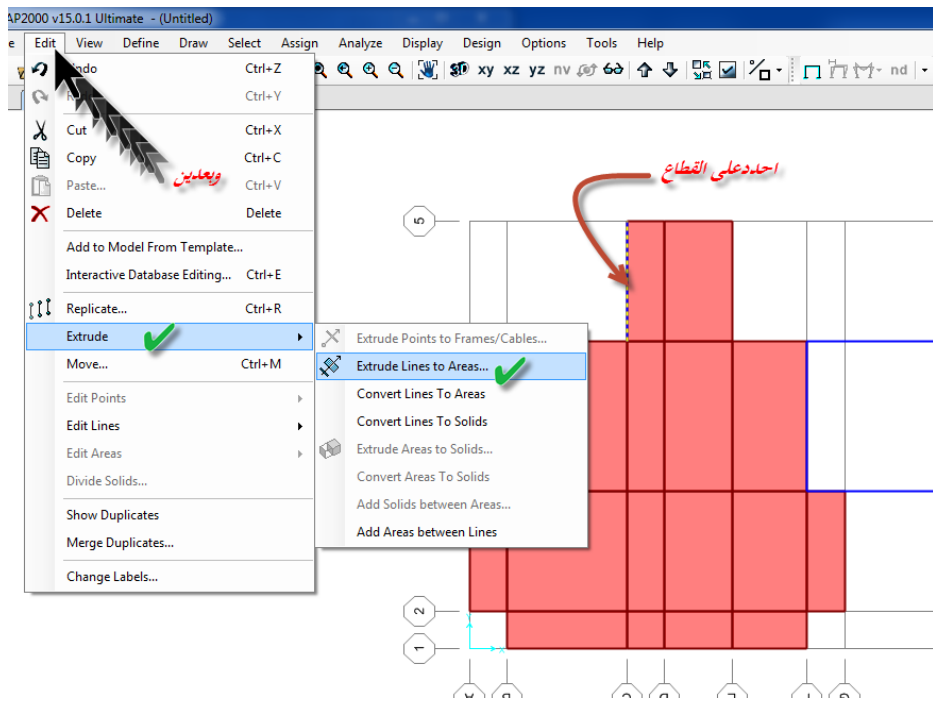
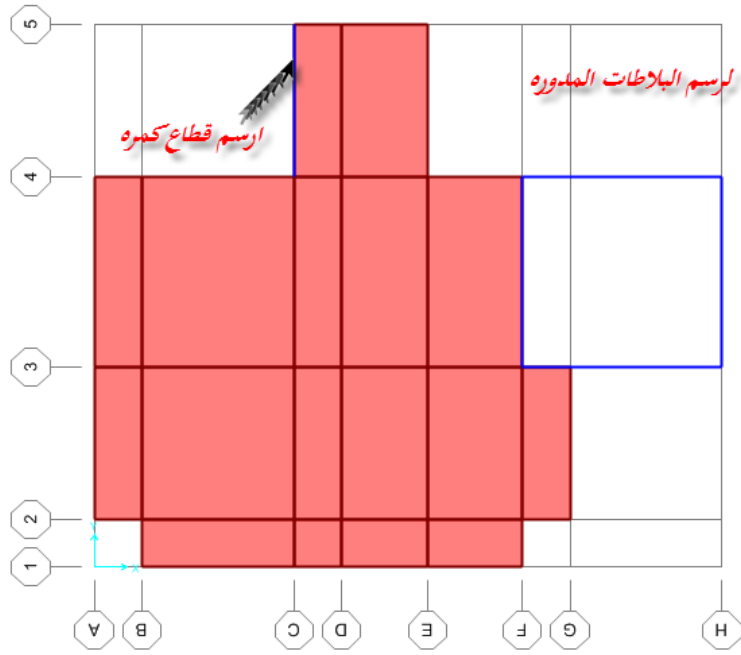

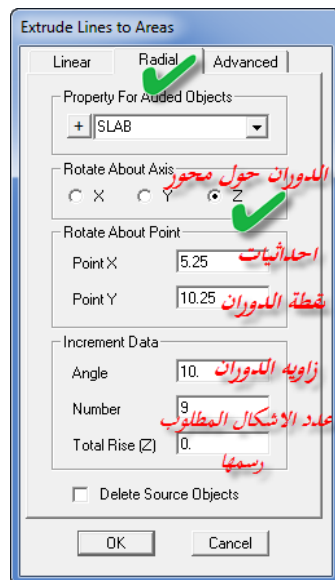
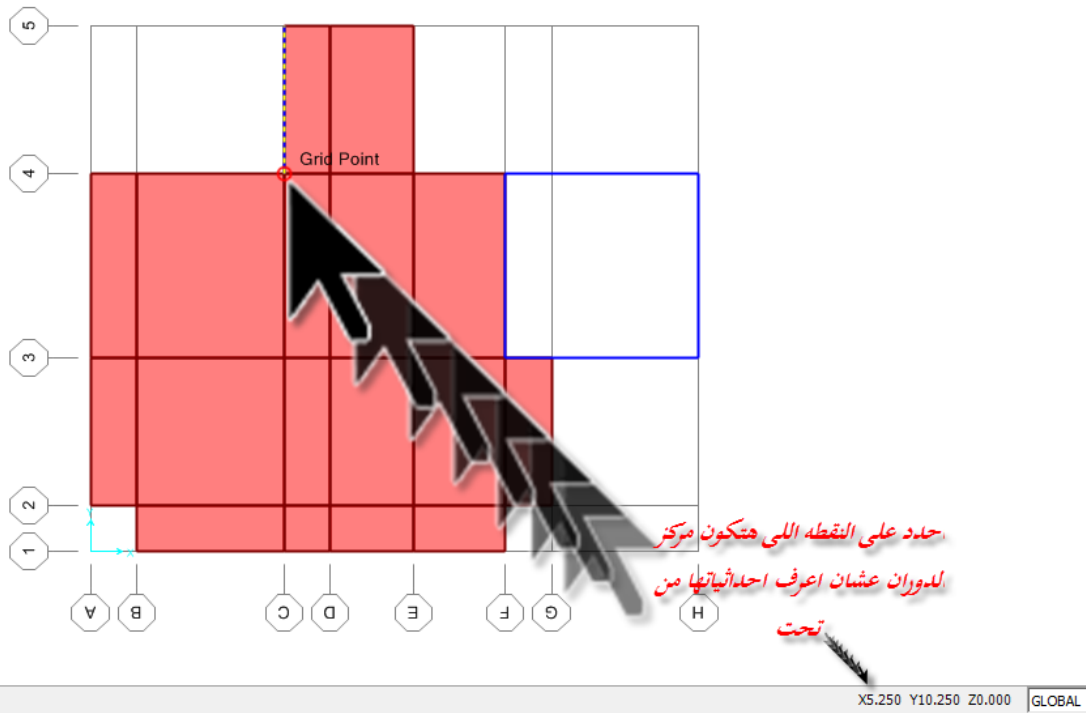

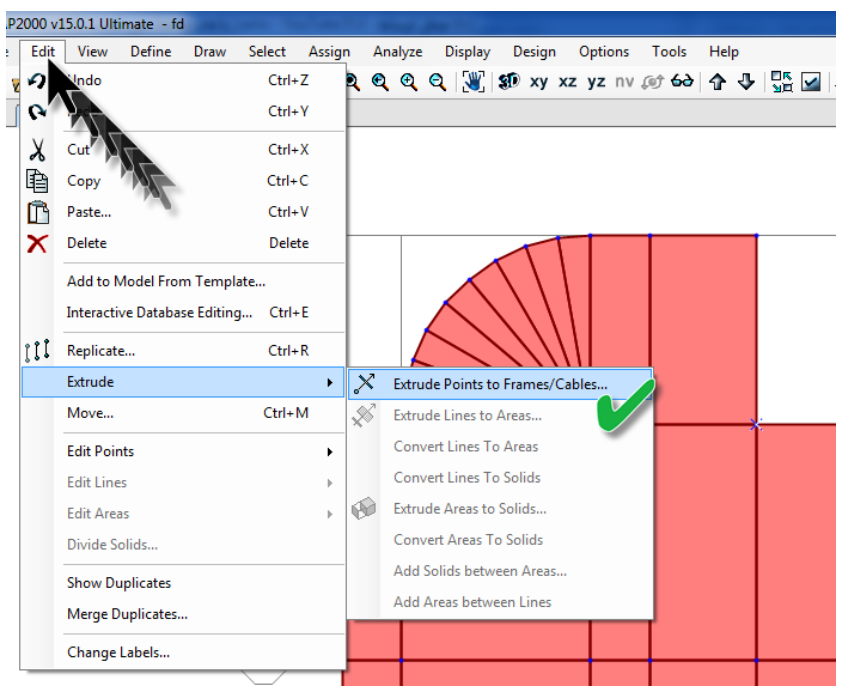
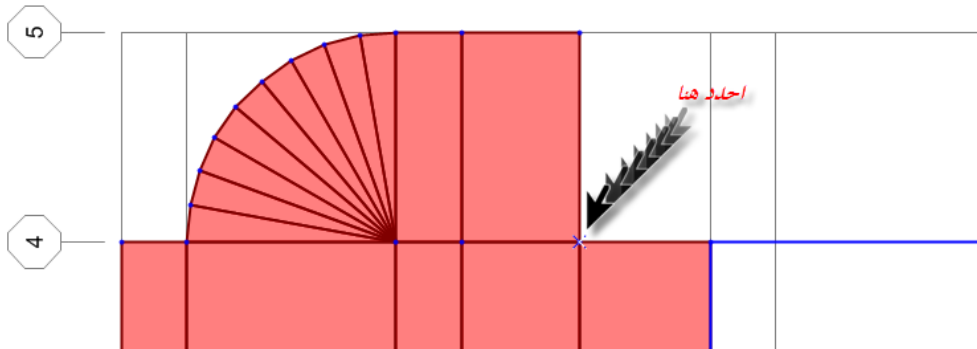
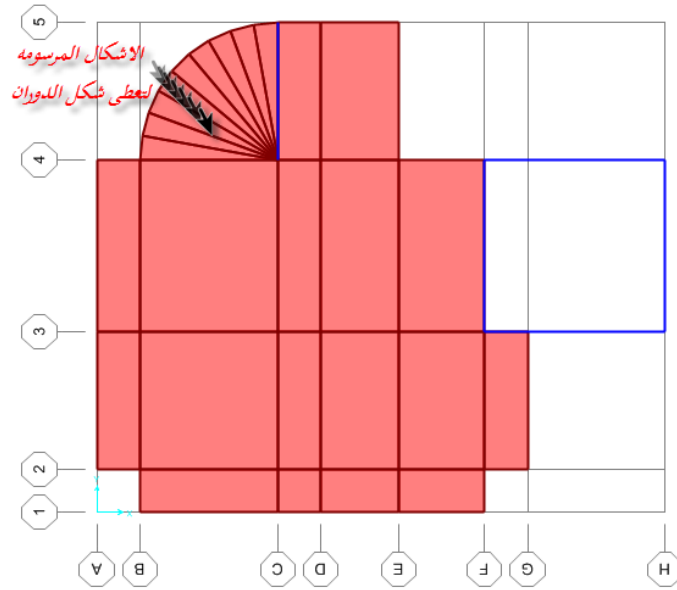

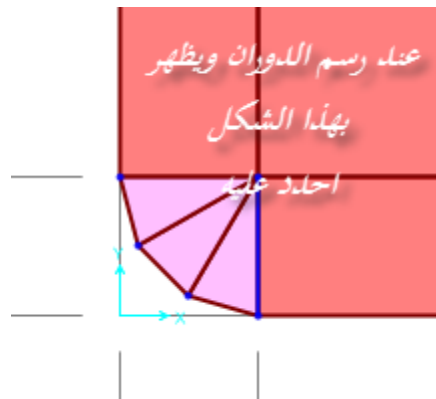
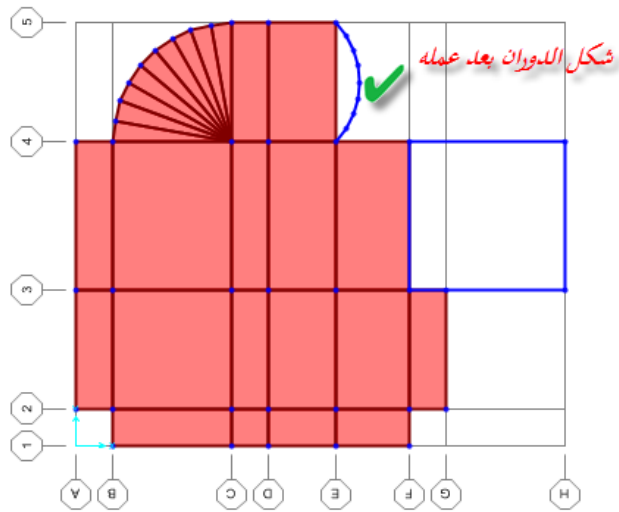
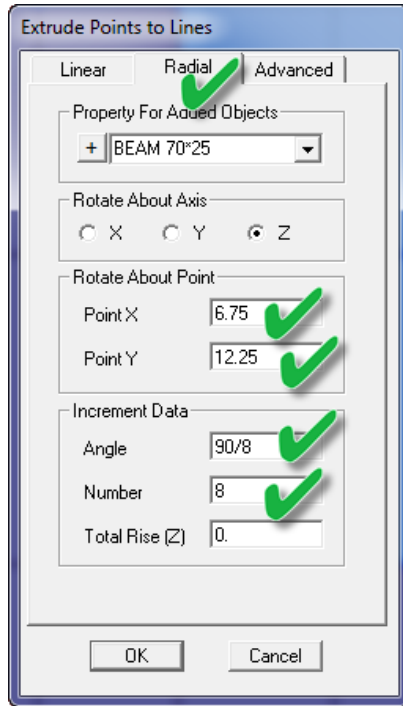

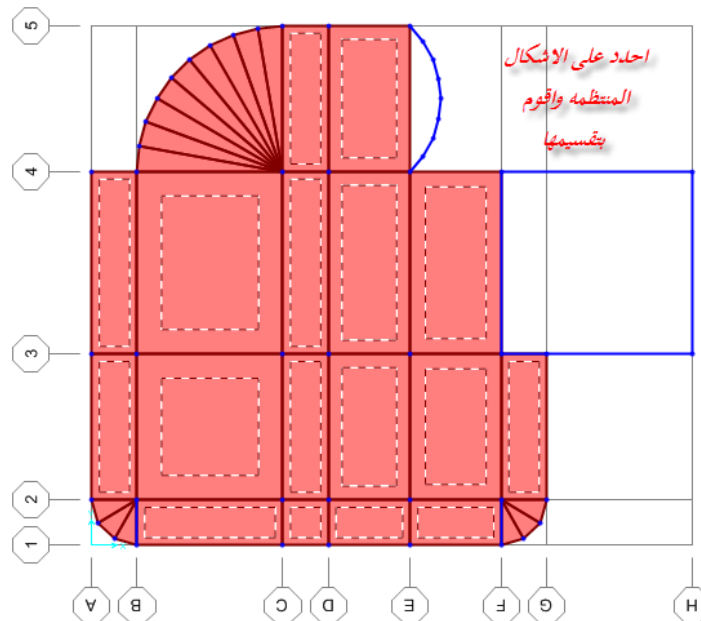
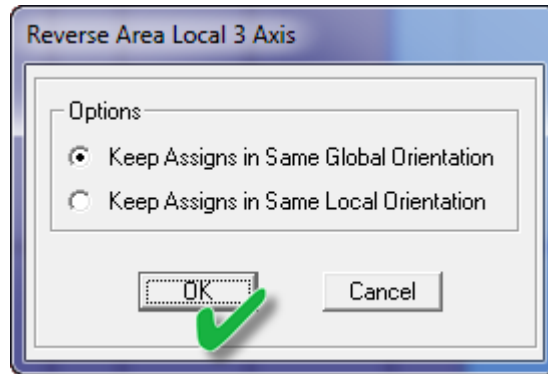
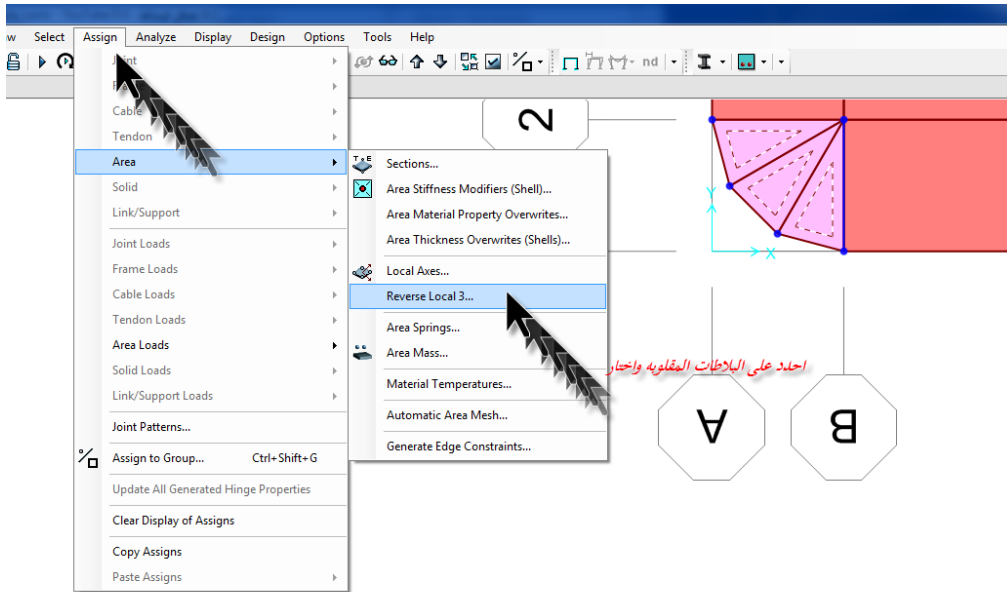

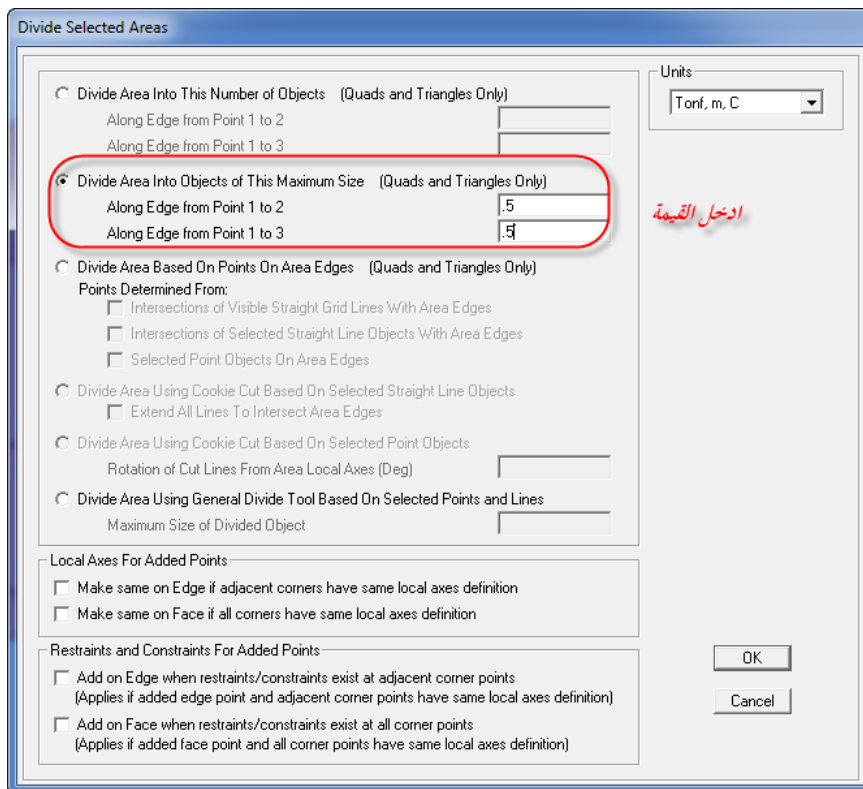
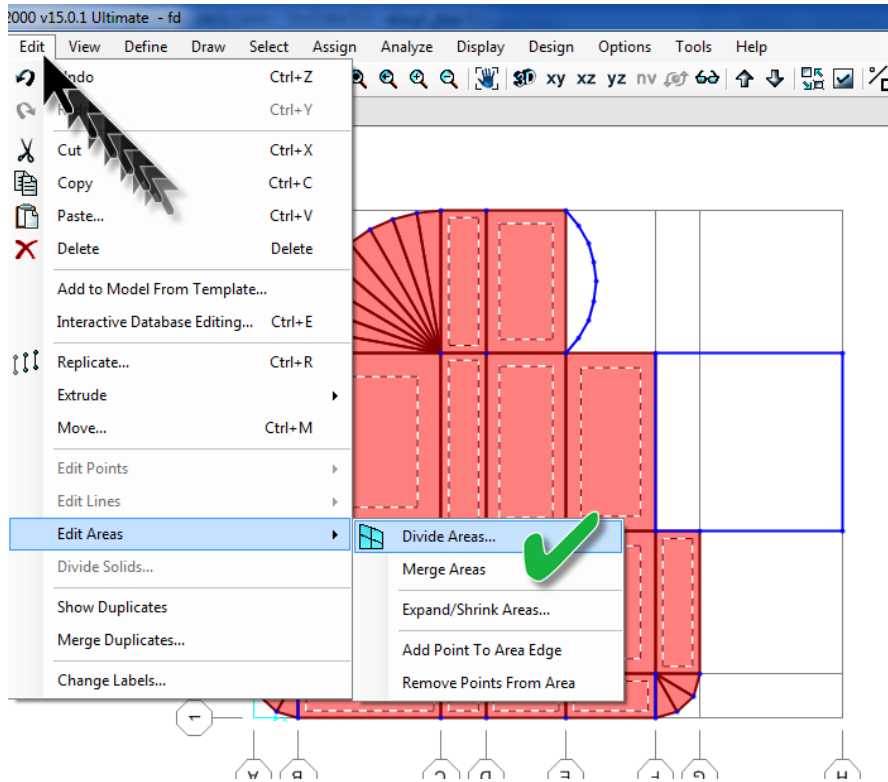

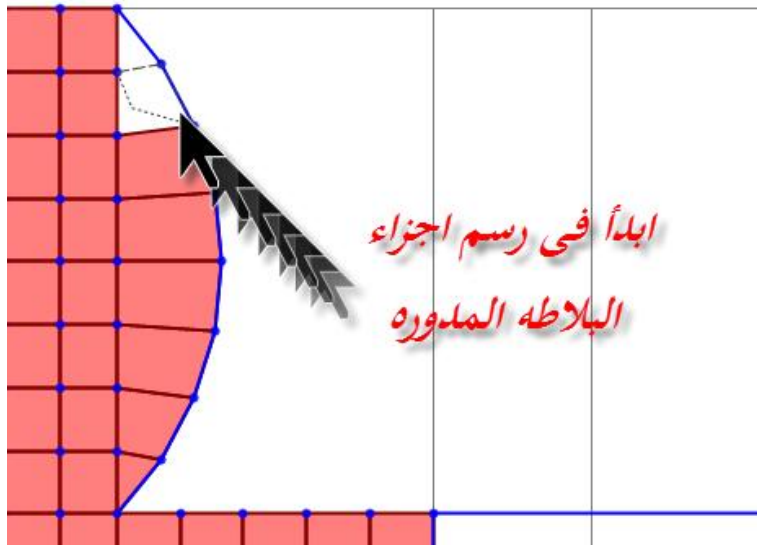
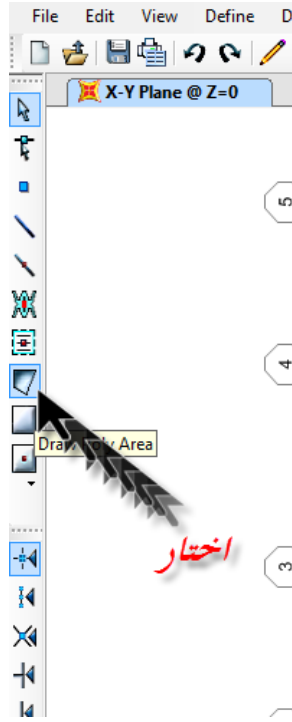

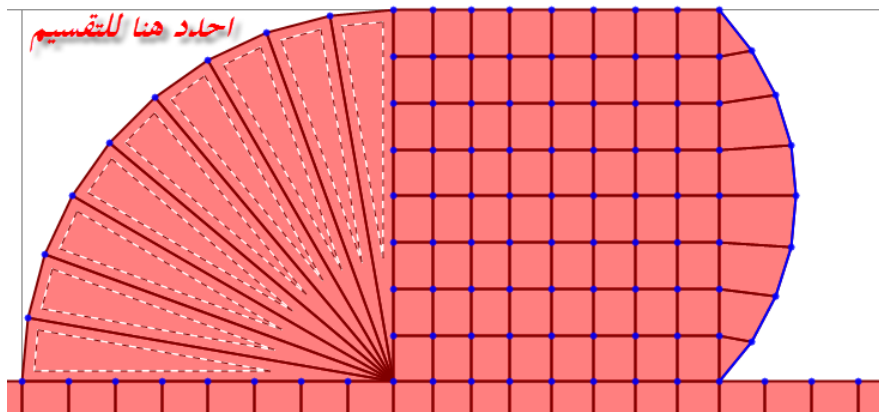

Divide Selected Areas

Divide Area Into This Number of Objects (Quads and Triangles Only)

Along Edge from Point 1 to 2 **احدد هنا واكتب القيمة** ✓

Along Edge from Point 1 to 3 ✓

Divide Area Into Objects of This Maximum Size (Quads and Triangles Only)

Along Edge from Point 1 to 2

Along Edge from Point 1 to 3

Divide Area Based On Points On Area Edges (Quads and Triangles Only)

Points Determined From:

Intersections of Visible Straight Grid Lines With Area Edges

Intersections of Selected Straight Line Objects With Area Edges

Selected Point Objects On Area Edges

Divide Area Using Cookie Cut Based On Selected Straight Line Objects

Extend All Lines To Intersect Area Edges

Divide Area Using Cookie Cut Based On Selected Point Objects

Rotation of Cut Lines From Area Local Axes (Deg)

Divide Area Using General Divide Tool Based On Selected Points and Lines

Maximum Size of Divided Object

Local Axes For Added Points

Make same on Edge if adjacent corners have same local axes definition

Make same on Face if all corners have same local axes definition

Restrains and Constraints For Added Points

Add on Edge when restrains/constraints exist at adjacent corner points
 (Applies if added edge point and adjacent corner points have same local axes definition)

Add on Face when restrains/constraints exist at all corner points
 (Applies if added face point and all corner points have same local axes definition)

Units

Tonf, m, C

OK

Cancel

الشكل بعد اضافة كل البلاطات وتقسيمها عليه

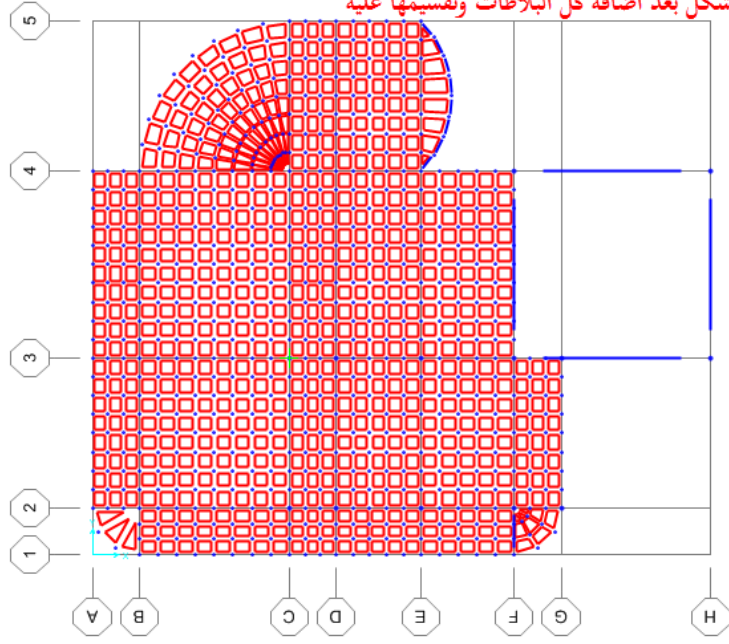

احدد مكان الركائز

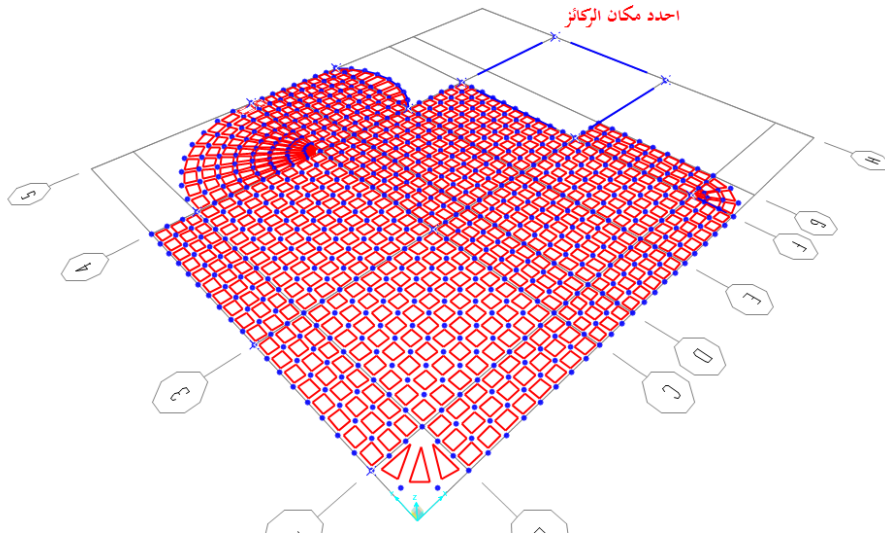

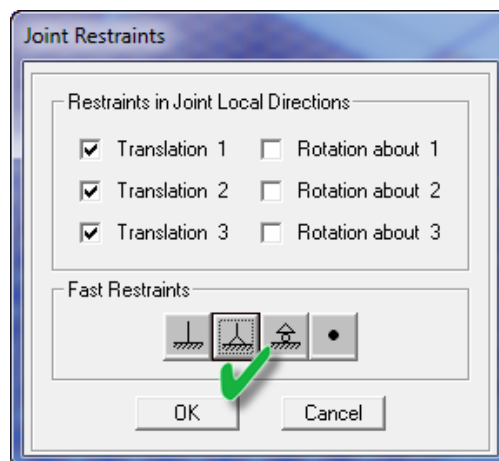
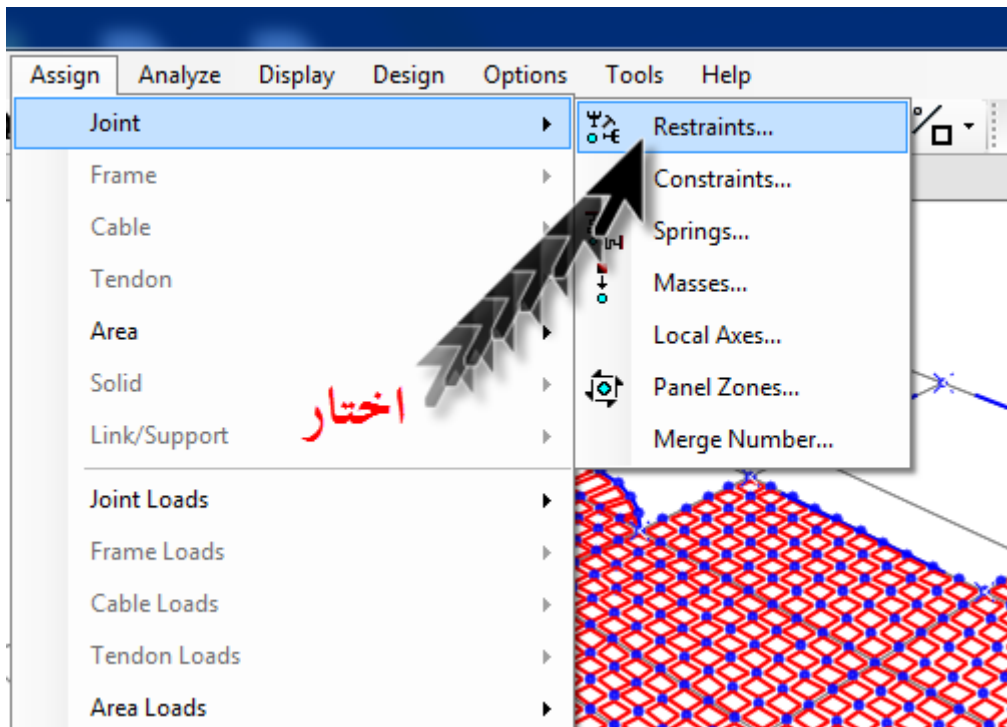

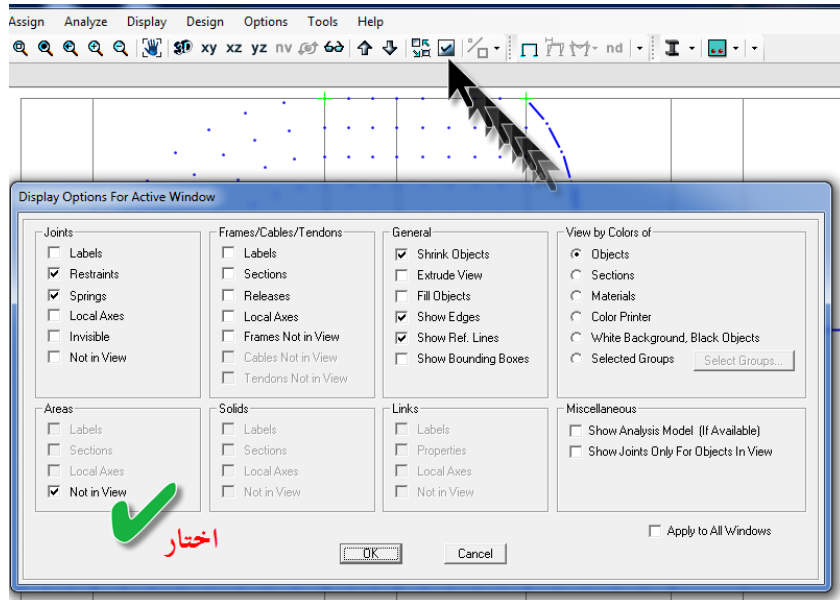
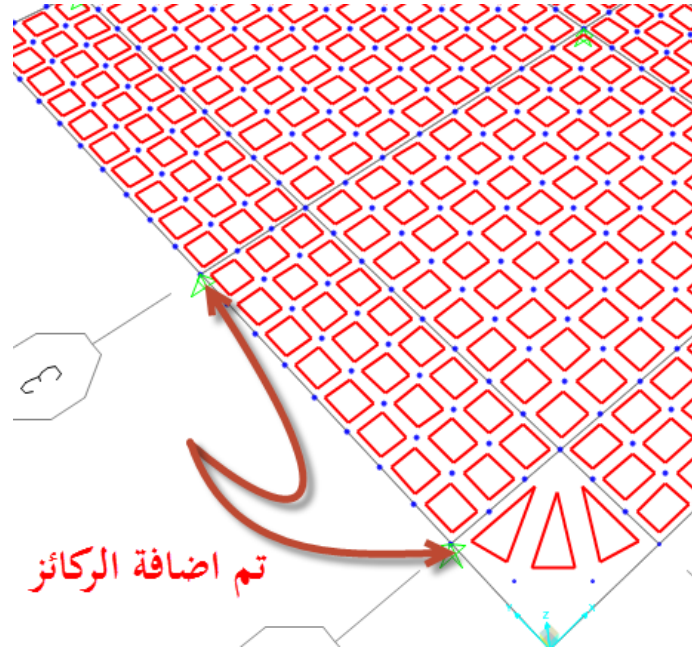

احدد لعمل الشير

وول على الركيزه

مع عدده نقاط

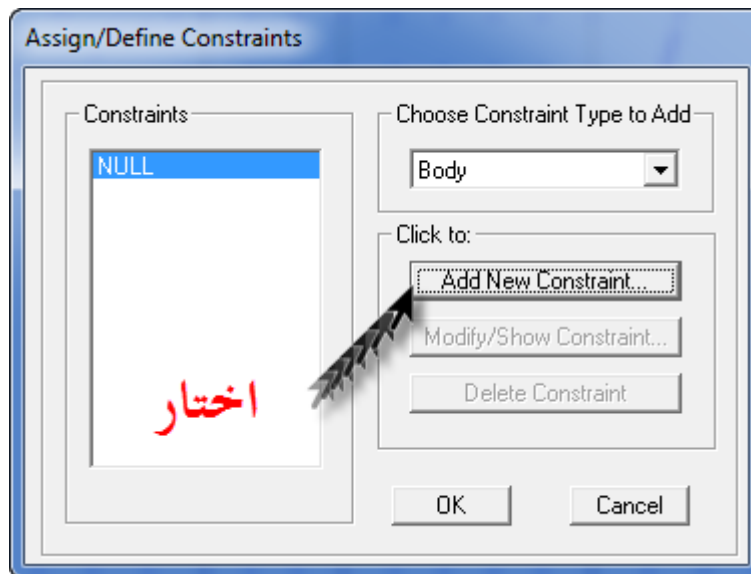
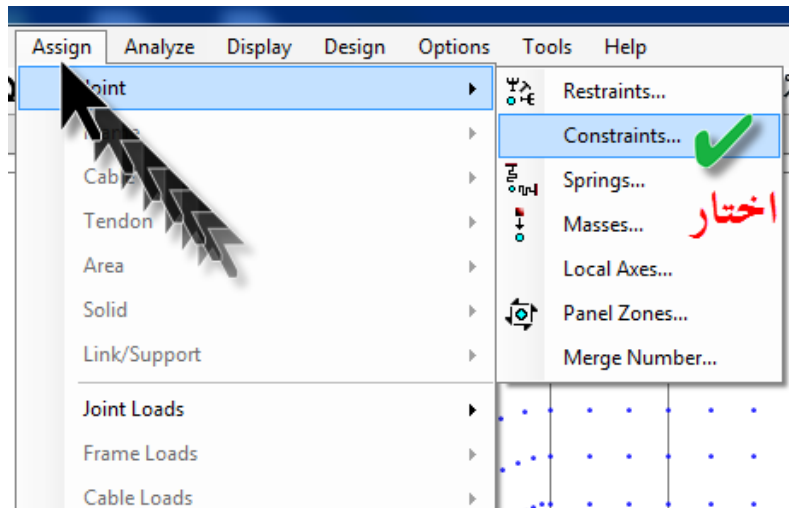
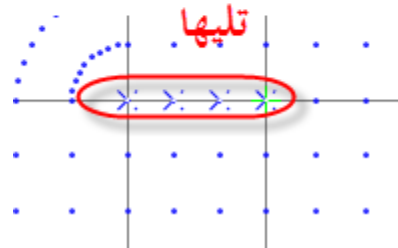

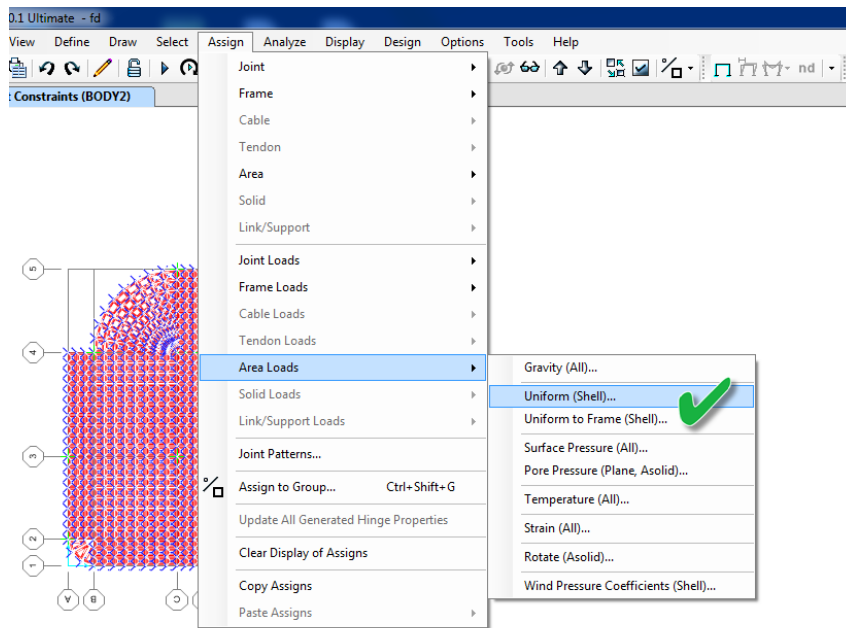
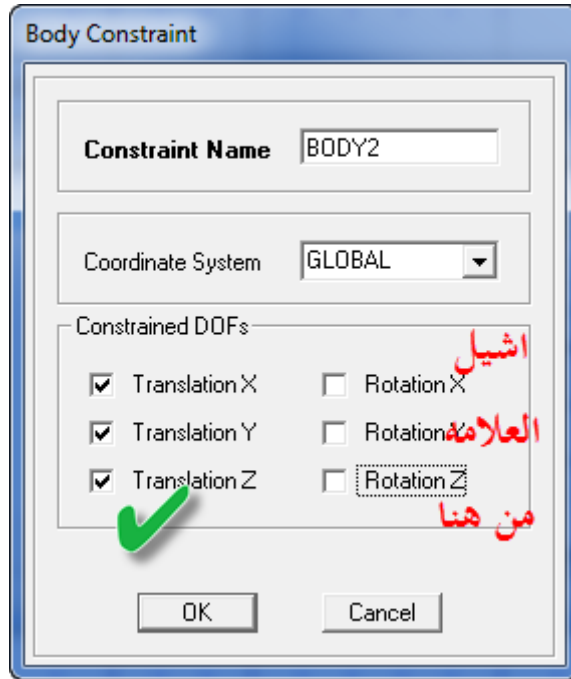



وبالمثل اضافة باقى الاحمال

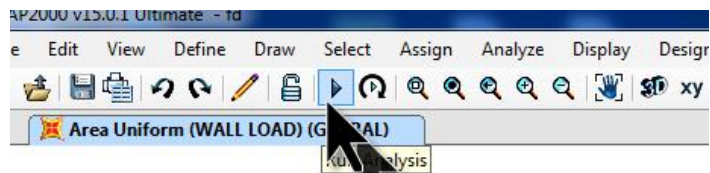

لبداء تحليل البلاطه

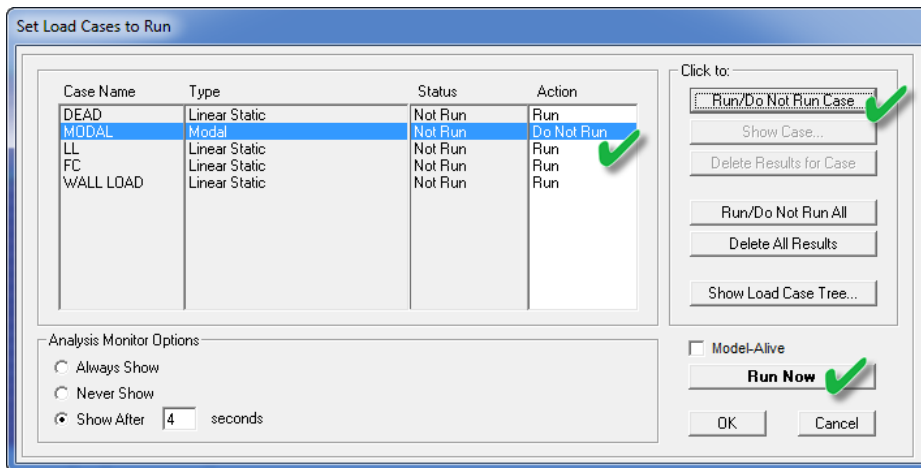
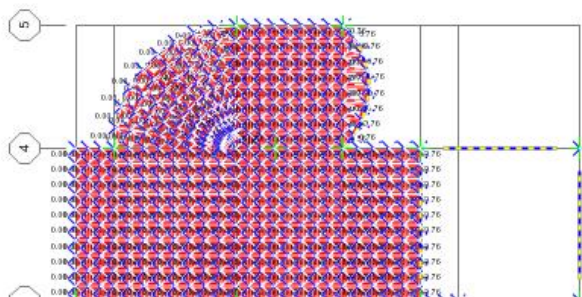

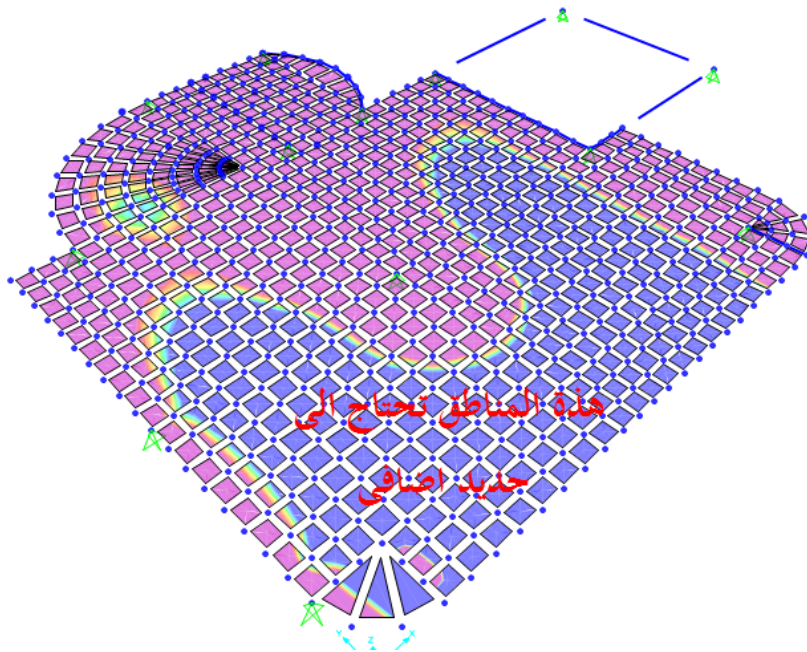
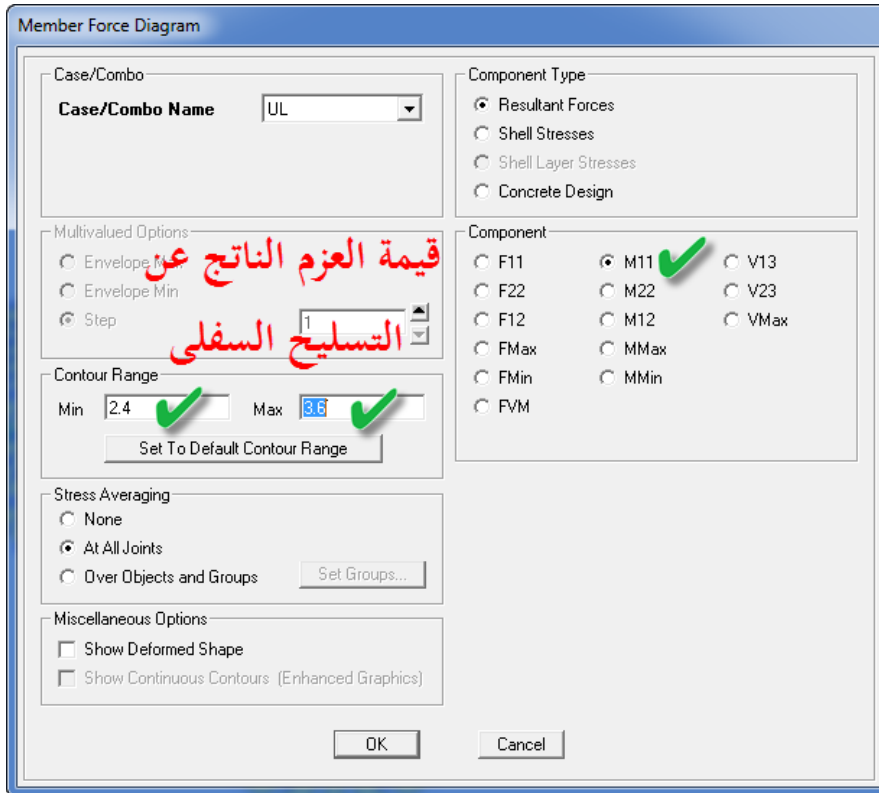

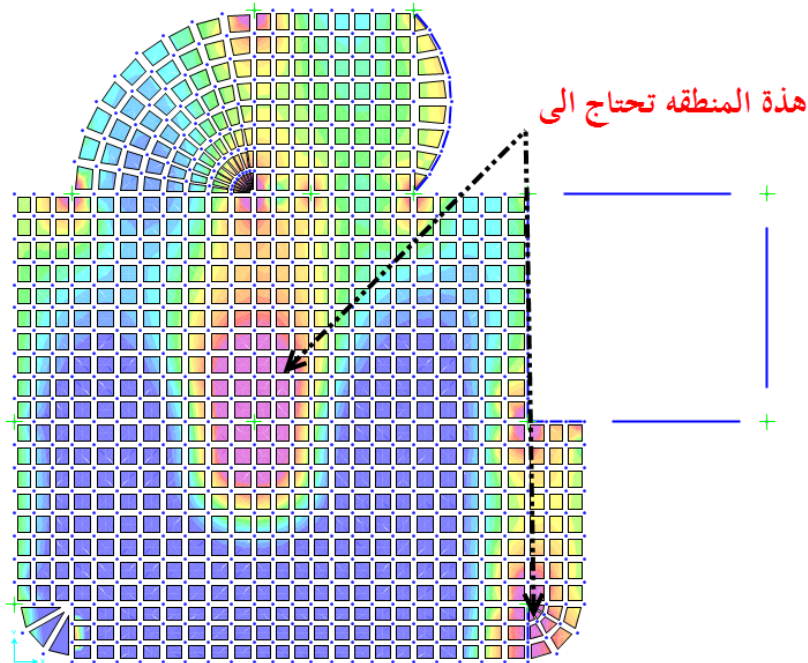
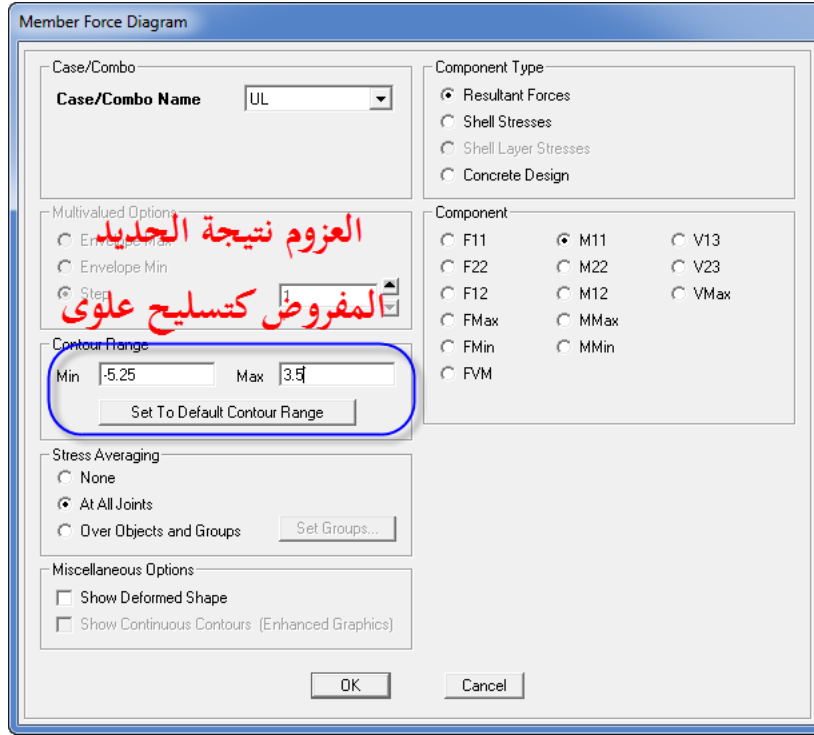

تم بحمد الله

مهندس : خالد عبدالكريم